

**SUTPHEN CORPORATION
MODEL SLTDA105
AERIAL LADDER
OPERATOR and MAINTENANCE MANUAL**



SUTPHEN

IMPORTANT

READ AND UNDERSTAND THIS MANUAL BEFORE OPERATING

FAILURE TO USE, UNDERSTAND, AND FOLLOW PROPER USAGE INSTRUCTIONS AS MADE AVAILABLE BY SUTPHEN CORPORATION/OPERATOR'S MANUAL, VARIOUS VENDOR SUPPLIED LITERATURE, GUIDELINES OF N.F.P.A., I.S.F.S.I., O.S.H.A., ETC., COULD CAUSE SERIOUS INJURY AND/OR DEATH.

**SUTPHEN
Since 1890**

www.sutphen.com
1-800-848-5860

Rev. 1 – Mar 2023
For Service Call:
1-866-287-5549



Chapter 1 Operator Manual

	<u>Page</u>
1.1 Introduction.....	1-4
1.2 Aerial Ladder Operation	1-5
<i>Operation Safety Points</i>	1-5
1.3 Rates Capacities	1-8
1.4 Safety Tags.	1-8
<i>Warning/Danger/Caution Labels List</i>	1-9
1.5 Cab Setup Procedure	1-21
<i>Locating the Vehicle</i>	1-21
<i>Activating the Hydraulic System</i>	1-21
1.6 Cab Setup for Fire Pump Operation.	1-23
1.7 Setup for Simultaneous Tower and Pump Operation.....	1-24
1.8 Aerial Ladder Setup Procedures.....	1-24
1.9 Stabilizing System.....	1-26
<i>Ground Jack Controls</i>	1-26
1.10 Ladder Operation	1-29
1.11 Ladder Function Controls	1-30
<i>Elevation</i>	1-30
<i>Extension</i>	1-30
<i>Rotation</i>	1-30
1.12 High Speed Controls	1-31
<i>Additional Pedestal Controls & Indicators</i>	1-31

▽ **Operator Manual**

	<i>Rung Alignment</i>	1-32
	<i>Panel Light Switch</i>	1-33
	<i>Alignment Light</i>	1-33
1.13	Ladder Positioning.....	1-33
	<i>Climbing Ladder or Using as an Escapeway</i>	1-34
1.14	Auxiliary Hydraulic Power Switch.....	1-34
1.15	Safety Interlock System.....	1-35
1.16	Water and Nozzle.....	1-36
	<i>Operation and Use</i>	1-36
	<i>Draining of Waterway and Nozzle</i>	1-36
1.17	Optional Breathing Air System.....	1-37
1.18	Return Aerial to Travel Position.....	1-38
	<i>Retract the Tower</i>	1-38
	<i>Lower the Tower</i>	1-38
	<i>Remove Wheel Chocks</i>	1-38
	<i>Retract the Stabilizers</i>	1-39

Chapter 2
Maintenance Manual

	<u>Page</u>
2.1 Aerial Maintenance.....	2-2
<i>Stabilizers</i>	2-2
<i>Main Lift Cylinders</i>	2-2
<i>Pivot Shaft Bearings</i>	2-2
<i>Turntable Bearing</i>	2-2



	<i>Rotation Gear Reducer</i>	2-3
	<i>Drive Gears</i>	2-4
	<i>Sheaves</i>	2-4
2.2	Extension System.....	2-4
	<i>Cable Adjustment Procedure</i>	2-4
	<i>Slide Blocks</i>	2-8
	<i>Waterway and Seals</i>	2-8
2.3	Water Lubrication Procedure.....	2-9
	<i>Waterway Nozzle</i>	2-10
	<i>Waterway Pinning Level</i>	2-10
	<i>Hydraulic Oil Tank</i>	2-10
	<i>Hydraulic Tank Fill Instruction</i>	2-11
2.4	Return Oil Filtration System.....	2-12
2.5	Maintenance of Structure.....	2-13
	<i>Aluminum Tower Structure</i>	2-13
	<i>Turntable Attachments</i>	2-13
	<i>Aerial Tower Lubrication and Maintenance Schedule</i>	2-15
	<i>Torque Specifications</i>	2-16
	<i>Walk Around Checks for Mobile Fire Apparatus</i>	2-17

Chapter 3

Warranty

Aerial Platform or Aerial Ladder Structural and Corrosion Warranty

Thirty (30) Years 3-2

Aerial Platform and Aerial Ladder Mechanical Warranty

Two (2) Years 3-3

Chapter 1

Operator Manual

	<u>Page</u>
1.1 Introduction.....	1-4
1.2 Aerial Ladder Operation	1-5
<i>Operation Safety Points</i>	1-5
1.3 Rates Capacities	1-8
1.4 Safety Tags.	1-8
<i>Warning/Danger/Caution Labels List</i>	1-9
1.5 Cab Setup Procedure	1-21
<i>Locating the Vehicle</i>	1-21
<i>Activating the Hydraulic System</i>	1-21
1.6 Cab Setup for Fire Pump Operation.	1-23
1.7 Setup for Simultaneous Tower and Pump Operation.....	1-24
1.8 Aerial Ladder Setup Procedures.....	1-24
1.9 Stabilizing System.....	1-26
<i>Ground Jack Controls</i>	1-26
1.10 Ladder Operation	1-29
1.11 Ladder Function Controls	1-30
<i>Elevation</i>	1-30
<i>Extension</i>	1-30
<i>Rotation</i>	1-30
1.12 High Speed Controls	1-31
<i>Additional Pedestal Controls & Indicators</i>	1-31



	<i>Rung Alignment</i>	1-32
	<i>Panel Light Switch</i>	1-33
	<i>Alignment Light</i>	1-33
1.13	Ladder Positioning.....	1-33
	<i>Climbing Ladder or Using as an Escapeway</i>	1-34
1.14	Auxiliary Hydraulic Power Switch.....	1-34
1.15	Safety Interlock System.....	1-35
1.16	Water and Nozzle.....	1-36
	<i>Operation and Use</i>	1-36
	<i>Draining of Waterway and Nozzle</i>	1-36
1.17	Optional Breathing Air System.....	1-37
1.18	Return Aerial to Travel Position.....	1-38
	<i>Retract the Tower</i>	1-38
	<i>Lower the Tower</i>	1-38
	<i>Remove Wheel Chocks</i>	1-38
	<i>Retract the Stabilizers</i>	1-39

1.1 Introduction

This manual has been written by service and engineering specialists. This manual will help acquaint you with the operation and maintenance of your apparatus, as well as the set-up and use of the tower during emergencies. You are urged to read this manual carefully. Following the instructions and recommendations in this manual will help ensure the safe and reliable operation of your apparatus.

After you have read this manual, it should be stored in the apparatus or another location for quick and easy reference for all firefighters.

Throughout this manual, the words **WARNING**, **DANGER**, and **CAUTION** appear. This serves as a reminder to follow all instructions carefully. Failure to follow instructions can cause personal injury or damage to your apparatus.

There may be circumstances that arise throughout the life of this apparatus which do not appear in this manual. At all times, common sense and safety should be your first consideration.

Thank you for purchasing your apparatus from Sutphen. We work toward giving you complete satisfaction. Sutphen knows your apparatus best and has the parts and factory-trained technicians available. Please do not hesitate to contact Sutphen at 1-866-287-5549.



1.2 Aerial Ladder Operation

Operation Safety Points

The aerial tower is only as good or as safe as the operator is competent. Continued training and familiarization are essential.

Personnel should not climb the aerial tower until the ground operator indicates it is safe to do so.

Do not operate turntable controls while personnel are climbing the tower.

Personnel should use a life belt when operating off the aerial tower.

At night, the entire aerial tower should be well lit.

Do not forcefully extend the end of the tower against a structure.

Never use the tower as a battering ram.

Never use the aerial tower for pulling down walls or structural members.

Never willingly or intentionally abuse an aerial tower by careless handling, overloading, or use for which it was not designed.

Operate the aerial tower with deliberate motions and smooth application of power.

The operator should always remain at the aerial controls while the aerial tower is in use.

Stabilizers with ground pads should always be used when operating the aerial tower.

 **Operator Manual**

Safety locks on stabilizers should always be in place.

Most problems encountered with the operation of the tower are caused by inadequate maintenance. To keep the tower fully operational, routine maintenance policies must be followed.

Frequently inspect the chassis and follow recommended schedules in this manual. The aerial tower is of no use unless it can be transported to where it is needed. Careful, safe driving rules should be observed for the same reason.

Carefully and frequently check and inspect the entire aerial tower equipment for loose bolts or rivets; un-lubricated bearing surfaces; bent, warped, or twisted parts; hydraulic leaks; defective electric control equipment; etc. Follow the recommended maintenance schedules in this manual.

All members should frequently practice the different phases of aerial tower operations.

Never set up the aerial tower on marshy ground, freshly filled ground, or other soft surfaces.

Never apply opposing alternating control when operating the aerial tower, either in a side-to-side motion, a front to rear motion, or an up and down motion. This may set up an accelerated oscillation which could put undue strain on the structure, cause immediate or eventual failure of the aerial tower, or cause injury to the occupants or bystanders.

Do not overload the tower. Observe the load limit. The load limit is 750 lbs. without water in the waterway, in any position of operation. Do not exceed the number of people it can hold.

Although the tower is designed for one-person operation, it is a good safety practice to

For Service Call

1-866-287-5549



designate a person to observe the right-side stabilizer when the stabilizers are being set up. This person can place the stabilizer pad, observe that it is placed evenly and correctly, and make sure the stabilizer is set properly.

Do not permit an untrained person, or a person who is not thoroughly familiar with this tower, to operate it unless constantly supervised.

The operator must:

1. Be capable of spotting the tower properly.
2. Be able to stabilize the tower properly.
3. Know the location of every control.
4. Know what each control does and how it works.
5. Be able to operate all controls smoothly and safely. Know the location of safety devices, how they work and how to operate.
7. Be familiar with the loads that the tower can safely accommodate under various operating conditions.
8. Be aware of how to operate the tower under unusual circumstances.

When you consider the lives at stake, the cost of an aerial tower and the damage that could occur to the equipment, the importance of training and practice becomes very clear.



WARNING

Before operating this apparatus, you must:

- 1. Be thoroughly familiar with this instruction manual.*
- 2. Be thoroughly trained in the operation of this apparatus.*
- 3. Operate this apparatus in strict accordance with the manufacturer's recommendations.*
- 4. Operate this apparatus in accordance with departmental rules and regulations.*
- 5. Always set up the apparatus on concrete, blacktop, or gravel. Surface must be firm and solid.*

▽ **Operator Manual**

6. Failure to do so could result in injury or death to persons operating or working on or around this apparatus.

7. Failure to do so could also result in damage to this apparatus.

1.3 Rated Capacities

Rated capacity of the 105' aerial ladder is 500 lbs. with water in the waterway, 750 lbs. without water in the waterway, in any position of operation.



WARNING

DO NOT exceed the rated capacities.

1.4 Safety Tags

On the following pages are the various safety tags found on the apparatus. All of the tags found here may not be used on your particular vehicle, as some are related to optional equipment. Should any of these tags become damaged or lost throughout the life of your vehicle, please contact Sutphen Corporation at 1-866-287-5549 for replacements.



WARNING / DANGER / CAUTION LABELS LIST

Tag 38-1	Horizontal Fumes Caution	Tag 18	Pinch Point Caution
Tag 382	Pressurized Inlets Warning	Tag 57A	Seated & Belted Warning
Tag 385	Jump Stud	Tag 58	Traction Warning
Tag 395C	Pump Overheat Procedure	Tag 59	Fan Warning
Tag 405	Power Line Down	Tag 60	Close Crosslay Cover Warning
Tag 406	Manual Override Outrigger Controls	Tag 66	Stand Clear of Outrigger Warning
Tag 37	Enclosed Seats Warning	Tag 449B	Water Tank Refill Caution
Tag 370	Platform Equipment	Tag 450B	Pressure Governor RPM Warning
Tag 371	Drain Yoke Caution	Tag 452	Generator PTO
Tag 375	Set Rear Jacks Caution	Tag 454B	Generator Wattage Caution
Tag 38	Fumes Caution	Tag 499	Sutphen Logo
Tag 381	ABS Code Switch	Tag 55	Battery Safety Precaution
Tag 326	Aerial Rappel Warning	Tag 55	Explosion Warning
Tag 327	Leveling Override Instruction	Tag 439	Install Safety Pin Label-Vertical
Tag 328	Open Valves	Tag 440	Equipment Weight Limit
Tag 36	Fire Caution	Tag 441	Manual Override Outrigger Controls (SPH)
Tag 365	Vehicle Capacity & Height Warning	Tag 442B	Lifting Eye Warning
Tag 368	Engage PTO Instruction	Tag 446	Lifting Eye Capacity
Tag 282	Stabilizer Interlock System	Tag 448	Differential Lock Engagement
Tag 310	Computer Code Switch	Tag 433	Power Source Specs.
Tag 322	Lowering Cab Warning	Tag 434B	Front Suction Elbow Caution
Tag 323A	Cab Safety Precautions	Tag 437	Ladder Rack Up/Down
Tag 324	Cab Tilt	Tag 438	Waterway Valve Override
Tag 325	Cab Tilt Latch	Tag 417	Engage Generator Instruction
Tag 19	Stand Clear Crushing Injury Warning	Tag 427B	Bumper Warning
Tag 20	Aerial Electrocutation Danger	Tag 428	Pump Valve Handle Warning
Tag 21B	Lifting Eye Warning	Tag 430	Sutphen Towers Pump Data
Tag 22	Climb Boom Danger	Tag 431	Chassis Data
Tag 23	Aerial Data	Tag 432	Fluid Data
Tag 281	Tire Chains Instruction	Tag 407B	Turntable Area Instruction
Tag 455	Ladder Belt Tie-Off Point Warning	Tag 408B	Down to Lock
Tag 10	Alignment Light	Tag 410	Do Not Walk Warning
Tag 15	Aerial Modification Warning	Tag 414	Install Safety Pins
Tag 16	Oil Caution	Tag 416	Safety Chain Fastened Warning
Tag 17	Avoid Electrocutation Danger		

Operator Manual



Sutphen Tag 38-1-A
 IC Assembly P/N 3000587-0106
 IC Label P/N 3000588-0106
 IC Bezel P/N 3000586
 Assembly, Size D Message Bezel with
 Horizontal Fumes Caution Label

TAG 38-1



Sutphen Tag 382
 IC Assembly P/N 3000587-0009
 IC Label P/N 3000588-0009
 IC Bezel P/N 3000586
 Assembly, Size D Message Bezel with
 Pressurized Inlets Warning Label

TAG 382



Sutphen Tag 385
 IC Label P/N 3001294-0001
 Jump Stud Label
 50% Scale

TAG 385



Sutphen Tag 395-C
 IC Assembly P/N 3000587-0020
 IC Label P/N 3000588-0020
 IC Bezel P/N 3000586
 Assembly, Size D Message Bezel with
 Pump Overheat Procedure Label

TAG 395C

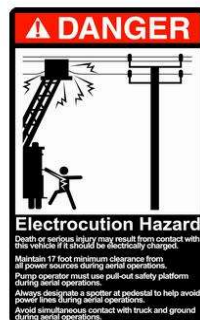

Sutphen Tag 405-A
 IC Label P/N 3001033-0002
 Power Line Danger Label
 50% Scale

TAG 405



Sutphen Tag 406-A
 IC Label P/N 3001035-0001
 Manual Override Outrigger Controls Label
 50% Scale

TAG 406



Sutphen Tag 37-A
IC Assembly P/N 3000587-0010
IC Label P/N 3000588-0010
IC Bezel P/N 3000586
Assembly, Size D Message Bezel with Enclosed Seats Warning Label

TAG 37

All equipment in the platform must be mounted in a holder. The total weight of equipment should not exceed 80 lbs.

Sutphen Tag 370
IC Label P/N 3001036-0001
Platform Equipment Label

TAG 370



Sutphen Tag 371
IC Assembly P/N 3000587-0049
IC Label P/N 3000588-0049
IC Bezel P/N 3000586
Assembly, Size D Message Bezel with Drain Yoke Caution Label

TAG 371

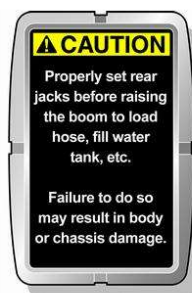

Sutphen Tag 375
IC Assembly P/N 3000587-0024
IC Label P/N 3000588-0024
IC Bezel P/N 3000586
Assembly, Size D Message Bezel with Set Rear Jacks Caution Label

TAG 375



Sutphen Tag 38
IC Assembly P/N 3000587-0019
IC Label P/N 3000588-0019
IC Bezel P/N 3000586
Assembly, Size D Message Bezel with Fumes Caution Label

TAG 38

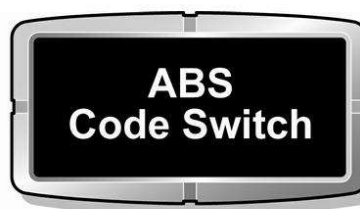

Sutphen Tag 381 -A
IC Assembly P/N 3000582-0002
IC Label P/N 3000584-0002
IC Bezel P/N 3000583
Assembly, Size C Message Bezel with ABS Code Switch Label

TAG 381

Operator Manual



Sutphen Tag 326-A
IC Label P/N 3001033-0001
Aerial Rappel Warning Label
50% Scale

TAG 326



Sutphen Tag 327
IC Assembly P/N 3000587-0031
IC Label P/N 3000588-0031
IC Bezel P/N 3000586
Assembly, Size D Message Bezel with
Leveling Override Instruction Label

TAG 327



Sutphen Tag 328
IC Assembly P/N 3000587-0028
IC Label P/N 3000588-0028
IC Bezel P/N 3000586
Assembly, Size D Message Bezel with
Open Valves Fall Hazard Danger Label

TAG 328



Sutphen Tag 36-A
IC Assembly P/N 3000587-0018
IC Label P/N 3000588-0018
IC Bezel P/N 3000586
Assembly, Size D Message Bezel with
Fire Caution Label

TAG 36



Sutphen Tag 365
IC Assembly P/N 3000587-0016
IC Label P/N 3000588-0016
IC Bezel P/N 3000586
Assembly, Size D Message Bezel with
Vehicle Capacity and Height Warning Label

TAG 365

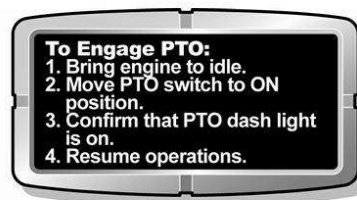

Sutphen Tag 368
IC Assembly P/N 3000582-0005
IC Label P/N 3000584-0005
IC Bezel P/N 3000583
Assembly, Size C Message Bezel with
Engage PTO Instruction Label

TAG 368

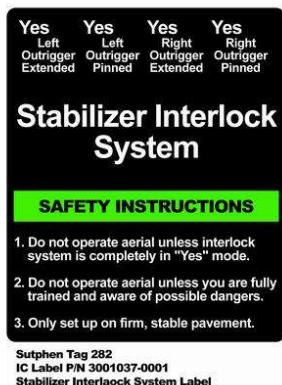

TAG 282

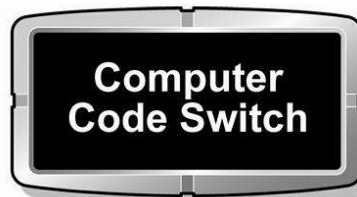

Sutphen Tag 310
IC Assembly P/N 3000582-0003
IC Label P/N 3000584-0003
IC Bezel P/N 3000583
Assembly, Size C Message Bezel with Computer Code Switch Label

TAG 310



Sutphen Tag 322-A
IC Assembly P/N 3000587-0004
IC Label P/N 3000588-0004
IC Bezel P/N 3000586
Assembly, Size D Message Bezel with Lowering Cab Warning Label

TAG 322



Sutphen Tag 323A
IC Assembly P/N 3000573-0001
IC Label P/N 3000575-0001
IC Bezel P/N 3000574
Assembly, Size B Message Bezel with Cab Safety Precautions Label

TAG 323A



Sutphen Tag 324
IC Assembly P/N 3000582-0001
IC Label P/N 3000584-0001
IC Bezel P/N 3000583
Assembly, Size C Message Bezel with Cab Tilt Label

TAG 324



Sutphen Tag 325-A
IC Assembly P/N 3000582-0004
IC Label P/N 3000584-0004
IC Bezel P/N 3000583
Assembly, Size C Message Bezel with Cab Tilt Latch Label

TAG 325

Operator Manual



Sutphen Tag 19-A
 IC Assembly P/N 3000587-0002
 IC Label P/N 3000588-0002
 IC Bezel P/N 3000586
 Assembly, Size D Message Bezel with
 Stand Clear Crushing Injury Warning Label

TAG 19



Sutphen Tag 20
 IC Assembly P/N 3000587-0026
 IC Label P/N 3000588-0026
 IC Bezel P/N 3000586
 Assembly, Size D Message Bezel with
 Aerial Electrocution Danger Label

TAG 20



Sutphen Tag 21-B
 IC Label P/N 3001032-0001
 Lifting Eye Warning Label

TAG 21B



Sutphen Tag 22
 IC Assembly P/N 3000587-0027
 IC Label P/N 3000588-0027
 IC Bezel P/N 3000586
 Assembly, Size D Message Bezel with
 Climb Boom Danger Label

TAG 22

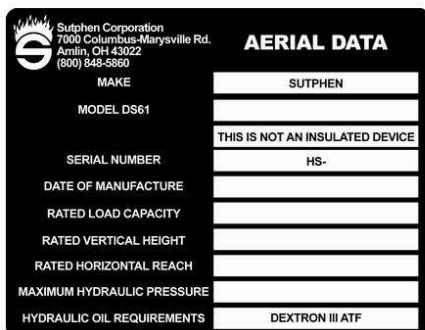

Sutphen Tag 23
 IC Label P/N 3001025-0001
 Aerial Data Label

TAG 23

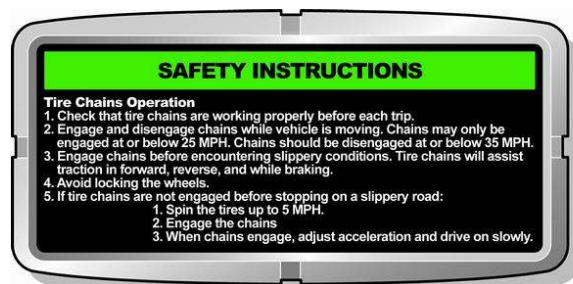

Sutphen Tag No. 281
 IC Assembly P/N 3000573-0002
 IC Label P/N 3000575-0002
 IC Bezel P/N 3000574
 Assembly, Size B Message Bezel with Tire Chains Instruction Label

TAG 281



Sutphen Tag No. 455-A
IC Label P/N 3001525-0001
Ladder Belt Tie-Off Point Warning Label

TAG 455

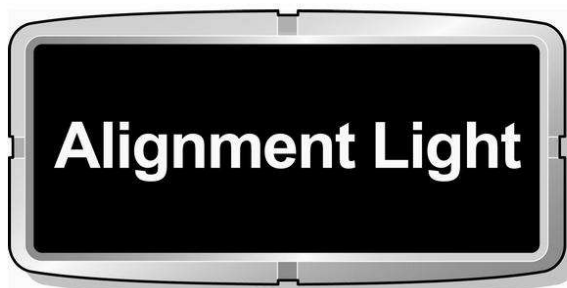

Sutphen Tag 10
IC Assembly P/N 3000573-0003
IC Label P/N 3000575-0003
IC Bezel P/N 3000574
Assembly, Size B Message Bezel with Alignment Light Label

TAG 10



Sutphen Tag 15-A
IC Assembly P/N 3000587-0017
IC Label P/N 3000588-0017
IC Bezel P/N 3000586
Assembly, Size D Message Bezel with Aerial Modification Warning Label

TAG 15



Sutphen Tag 16
IC Assembly P/N 3000587-0022
IC Label P/N 3000588-0022
IC Bezel P/N 3000586
Assembly, Size D Message Bezel with Oil Caution Label

TAG 16



Sutphen Tag 17
IC Assembly P/N 3000587-0025
IC Label P/N 3000588-0025
IC Bezel P/N 3000586
Assembly, Size D Message Bezel with Avoid Electrocution Danger Label

TAG 17



Sutphen Tag 18-A
IC Assembly P/N 3000587-0021
IC Label P/N 3000588-0021
IC Bezel P/N 3000586
Assembly, Size D Message Bezel with Pinch Point Caution Label

TAG 18

Operator Manual



Sutphen Tag 57-A
IC Assembly P/N 3000587-0001
IC Label P/N 3000588-0001
IC Bezel P/N 3000586
Assembly, Size D Message Bezel with Seated and Belted Warning Label

TAG 57A



Sutphen Tag 58
IC Assembly P/N 3000587-0012
IC Label P/N 3000588-0012
IC Bezel P/N 3000586
Assembly, Size D Message Bezel with Traction Warning Label

TAG 58



Sutphen Tag 59-A
IC Assembly P/N 3000587-0006
IC Label P/N 3000588-0006
IC Bezel P/N 3000586
Assembly, Size D Message Bezel with Fan Warning Label

TAG 59



Sutphen Tag 60-A
IC Assembly P/N 3000587-0007
IC Label P/N 3000588-0007
IC Bezel P/N 3000586
Assembly, Size D Message Bezel with Close Crosslay Cover Warning Label

TAG 60



Sutphen Tag 66-A
IC Assembly P/N 3000587-0003
IC Label P/N 3000588-0003
IC Bezel P/N 3000586
Assembly, Size D Message Bezel with Stand Clear of Outrigger Warning Label

TAG 66



Sutphen Tag 449-B
IC Assembly P/N 3000582-0021
IC Label P/N 3000584-0021
IC Bezel P/N 3000583
Assembly, Size C Message Bezel with Water Tank Refill Caution Label

TAG449B



Sutphen Tag 450-B
IC Assembly P/N 3000587-0110
IC Label P/N 3000588-0110
IC Bezel P/N 3000586
Assembly, Size D Message Bezel with
Pressure Governor RPM Warning Label

TAG 450B



Sutphen Tag 452-A
IC P/N 3001514-0001
Generator PTO Label

TAG 452



Sutphen Tag 454-B
IC Assembly P/N 3001489-0016
IC Label P/N 3001487-0016
IC Bezel P/N 3001489
Assembly, Size E Message Bezel with
Generator Wattage Caution Label

TAG 454B



Sutphen Tag CHT-499
IC Label P/N 3001431-0001
Sutphen Logo Label

TAG 499

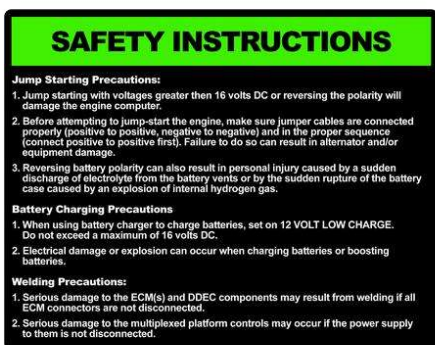

Sutphen Tag 55-A
IC Label P/N 3001029-0001
Battery Safety Precautions Label

TAG 55



Sutphen Tag 56-A
IC Assembly P/N 3000587-0008
IC Label P/N 3000588-0008
IC Bezel P/N 3000586
Assembly, Size D Message Bezel with
Explosion Warning Label

TAG 56

Operator Manual

-INSTALL SAFETY PIN

Sutphen Tag 439
IC Label P/N 3001228-0002
Install Safety Pin Label - Vertical
50% Scale

TAG 439



Sutphen Tag 440
IC Assembly P/N 3000587-0104
IC Label P/N 3000588-0104
IC Bezel P/N 3000586
Assembly, Size D Message Bezel with
Equipment Weight Limit Label

TAG 440

UP Front Axle Lock DOWN	RET Right Front Stabilizer EXT	RET Left Front Stabilizer EXT	UP Right Stabilizer DOWN	UP Left Stabilizer DOWN	UP Rear Stabilizer DOWN
----------------------------------	---	--	-----------------------------------	----------------------------------	----------------------------------

Sutphen Tag No. 441
IC Label P/N 3001397-0001
Manual Override Outrigger Controls Label (SPH)
50% Scale

TAG 441



Sutphen Tag 442-B
IC Label P/N 3001032-0002
Lifting Eye Warning Label

TAG 442B

SAFETY INSTRUCTIONS

1. Lifting eye capacity - 800 lbs.
2. Any weight suspended from eye must be subtracted from platform capacity.

Sutphen Tag 446
IC Label P/N 3001434-0001
Lifting Eye Capacity Label

TAG 446

When differential lock is engaged, the maximum speed is 25 MPH.

Sutphen Tag 448
IC Label P/N 300584-0018
Differential Lock Engagement Label

TAG 448

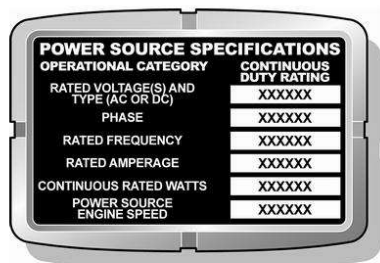

Sutphen Tag 433
IC Assembly P/N 3000587-0044
IC Label P/N 3000588-0044
IC Bezel P/N 3000586
Assembly, Size D Message Bezel with Power Source Specs. Label

TAG 433



Sutphen Tag 434-B
IC Label P/N 3001658
Keep Legs Inside Kick Guard Warning Label

TAG 434B



Sutphen Tag 435 A
IC Assembly P/N 3000582-0017
IC Label P/N 3000584-0017
IC Bezel P/N 3000583
Assembly, Size C Message Bezel with Auto-Pump Compressor Drain Label

TAG 435

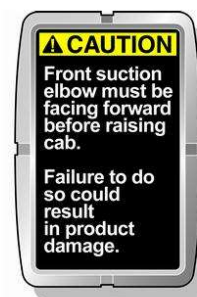

Sutphen Tag 436-B
IC Assembly P/N 3000587-0102
IC Label P/N 3000588-0102
IC Bezel P/N 3000586
Assembly, Size D Message Bezel with Front Suction Elbow Caution Label

TAG 436B



Sutphen Tag 437
IC Assembly P/N 3000582-0018
IC Label P/N 3000584-0018
IC Bezel P/N 3000583
Assembly, Size C Message Bezel with Ladder Rack Up/Down Label

TAG 437



Sutphen Tag 438
IC Assembly P/N 3000587-0103
IC Label P/N 3000588-0103
IC Bezel P/N 3000586
Assembly, Size D Message Bezel with Waterway Valve Override Label

TAG 438

Operator Manual

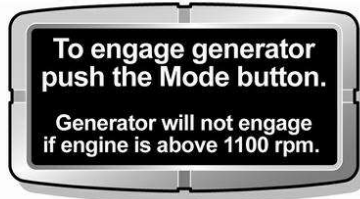

Sutphen Tag 417-A
IC Assembly P/N 3000582-0006
IC Label P/N 3000584-0006
IC Bezel P/N 3000583
Assembly, Size C Message Bezel with Engage Generator Instruction Label

TAG 417



Sutphen Tag 427-B
IC Assembly P/N 3000587-0034
IC Label P/N 3000589-0034
IC Bezel P/N 3000586
Assembly, Size D Message Bezel with Bumper Warning Label

TAG 427B

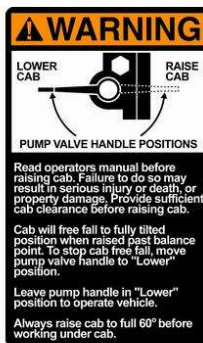

Sutphen Tag 428
IC Label P/N 3001031-0001
Pump Valve Handle Warning Label

TAG 428

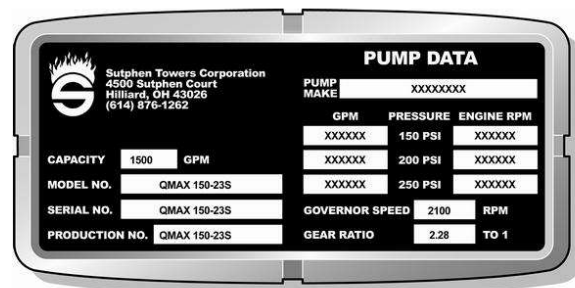

IC Assembly P/N 3000576-0001-SUTT
IC Label P/N 3000578-0001-SUTT
IC Bezel P/N 3000577
Assembly, Size A Message Bezel with Sutphen Towers Pump Data Label

TAG 430



Sutphen Tag 431
IC Label P/N 3001026-0001
Chassis Data Label

TAG 431

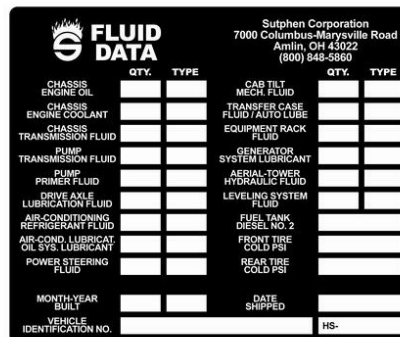

Sutphen Tag 432
IC Label P/N 3001027-0001
Fluid Data Label

TAG 432



1.5 Cab Setup Procedures

Locating the Vehicle

1. Spot the rig about 30 to 35 feet from the building when possible. This will give you maximum vertical coverage of the building.
2. Set the parking brake.
3. Place the transmission in neutral.
4. Make sure apparatus is on firm pavement, and that it is clear of overhead obstacles, such as poles, trees, wires, building overhang, etc.
5. Make sure that the outriggers are not going to sit upon manhole covers, drains, or grates in the street or on sidewalks.
6. Good judgement must be used in locating the apparatus at the fire scene. Ideal conditions may not always exist, so caution must be used to determine as safe a location as possible for the apparatus.

Activating the Hydraulic System

There is a PTO (Power Take-Off) which operates the hydraulic pump, providing hydraulic pressure to the system.



CAUTION

An electric switch located near the center of the cab dash panel activates the PTO. A pilot light will come on when the PTO switch is moved to the “in” position.

1. Engine must be at idle RPM.
2. Be sure there is at least 90 lbs. of air pressure on the truck air system.
3. The truck must be at complete stop, parking brake set, and transmission in neutral (N).
4. Move PTO switch on dash to “in” position. (Wait about 2 seconds.)

The cab controls are now set to operate the hydraulic system.

Operator Manual



If the fire pump is **not** to be used, proceed to **AERIAL LADDER SET-UP** on page 1-24 of this manual. The operator should move to the hydraulic system control compartment, located at the driver side, on the gooseneck of the trailer.



Mode Button and Pilot Light (1) for Generator PTO



1.6 Cab Setup for Fire Pump Operation (If Applicable)

NOTE: See Fire Pump Manual for more detailed information.

1. The truck must be stopped and parking brake set.
2. Truck transmission must be in neutral (N) position.
3. Engine must be at idle RPM.
4. Move the pump shift lever from ROAD position to PUMP position. This is done by raising the yellow locking collar and pulling back on the lever. Notice the green PUMP ENGAGEMENT light will come on. Pause in the middle to let air exhaust in between shifting.



Air Pump Shift



Electronic Pump Shift

5. (Only if the pump is wet)
Shift transmission to drive (D) (1-4) position. Power from the engine is now being transferred to the pump drive gear and pump impellers are turning. Observe the illuminated green indicator light next to the shift lever. If the light is not on, the pump is not engaged, pause for 3 seconds, then repeat steps 1-5 and observe for pump engagement.
6. To have the pump ready for operation later, leave transmission selector in neutral (N). For pump operation, simply put transmission selector in drive (D) (1-4).

1.7 Setup for Simultaneous Tower and Pump Operations

1. Follow steps for placing PTO in gear on page 1-21.
2. Follow Aerial ladder setup instructions on page 1-24.
3. Leave transmission selector in “neutral” for the pump to be ready to operate without churning.
4. Repeat steps 4 through 6 for placing pump in gear.

NOTE: When arriving at a structure fire or on occasion where the tower is not immediately needed, but the fire pump is being used, place the PTO in gear and deploy the ground stabilizer before placing the fire pump in gear. Then, if the need to use the tower arises while the fire pump is being used, the stabilizers can be set, and the tower will be ready for immediate use. If the PTO is not engaged before the pump is set up, then slow the engine to idle before engaging PTO.



CAUTION

Attempting to place the PTO in gear with the pump in gear will result in serious damage to the PTO and transmission—unless engine speed is at an idle of approximately 700 RPM's.

1.8 Aerial Ladder Setup Procedures

The lower operator's station in the trailer gooseneck has all the necessary controls for stabilizer deployment (*See fig. 1*). In addition to the standard controls illustrated, this may contain other optional controls or gauges, such as remote generator start controls or a PTO hour meter.

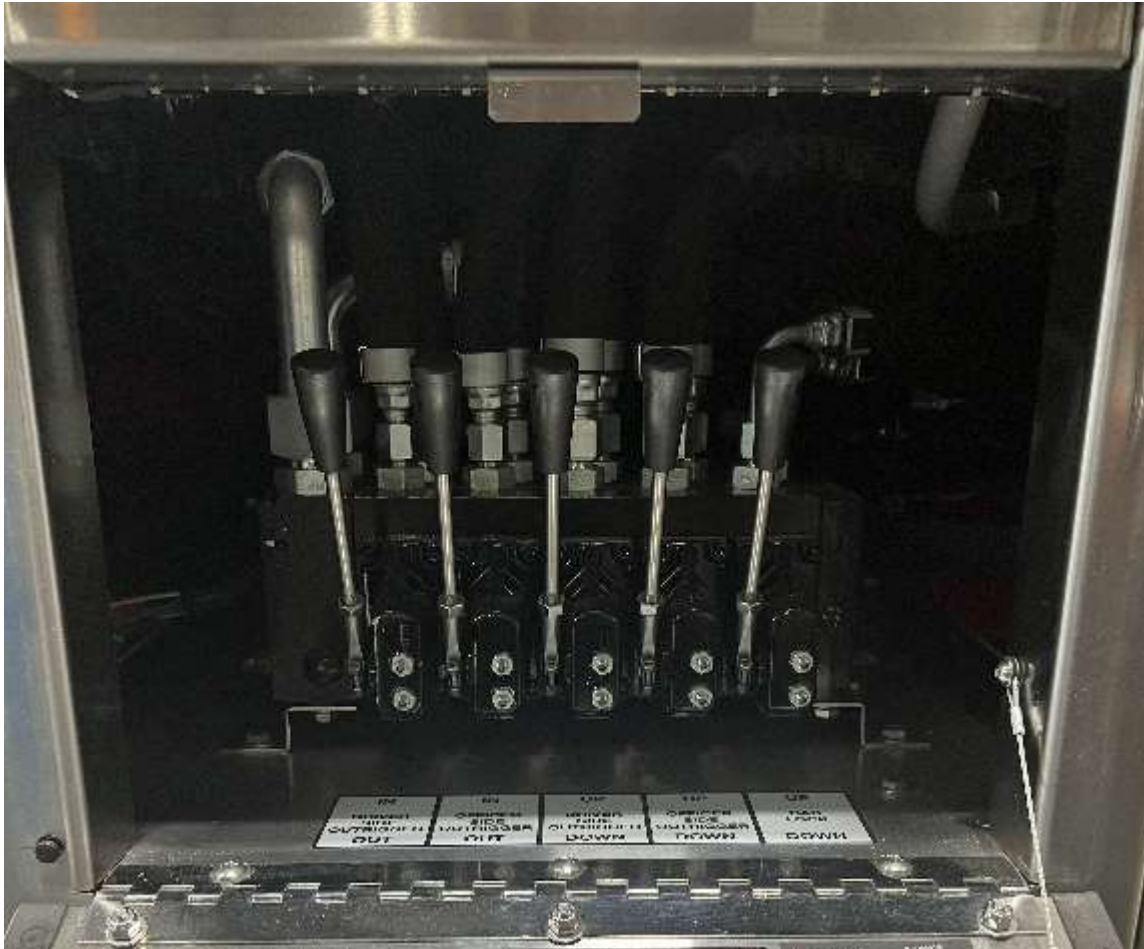

Figure 1- Lower Operator's Station

NOTE: An instruction plate is mounted directly beneath the hydraulic valve body. This plate identifies the function and operation of each handle on the valve body.

 **Operator Manual**

1.9 Stabilizing System

This system consists of eight double-acting hydraulic cylinders. Two of the cylinders permit the extension of the main outriggers to be located in such a manner as to allow for curbs, potholes, alleys or narrow locations between other vehicles. All cylinders are provided with double pilot-operated check valves to ensure constant holding position of any outrigger after it has been set in position. The main stabilizers (outriggers) are provided with large steel feet that swivel to allow them to adjust to the contour of the ground surface. Auxiliary ground jack pads are provided for the outriggers and should be used every time the tower is set up. A front jack system is provided on all models.



DANGER

Always set up the apparatus on concrete, blacktop, or gravel. Surface must be firm and solid. Soil/ground surfaces are not desirable, as the outrigger may sink into the ground causing a tip over. Soil surfaces that seem stable upon setup may erode with fire scene runoff water, thus making them unstable. Asphalt parking lot surfaces are typically thin and in hot weather may allow the outrigger to sink through, especially if the subsurface material is sand.

Ground Jack Controls

1. Leave transmission in neutral.
2. Set parking brake.
3. Engage Aerial PTO at engine idle.
4. Exit cab.
5. Place wheel chocks approximately 3” in front of and behind front tire.
6. Extend the main stabilizers by pulling the handles marked “LEFT JACK IN/OUT” and “RIGHT JACK IN/OUT” toward you. An audible alarm will begin to sound as the stabilizers move from their stowed position.



WARNING

Exercise caution when extending the opposite side stabilizer, taking care to watch it closely as it is extended. Personal injury or damage to property and/or the stabilizer may occur if the stabilizer is deployed improperly. Always use a spotter when available.



-
7. Main stabilizers may be extended simultaneously if desired by pulling both handles but pull each handle individually at full extension to insure both outriggers have gone full stroke. Remember, the safety interlock system will not allow operation of the aerial if the stabilizers are not properly extended.
 8. Place the ground pads under the stabilizer feet.
 9. Lower the stabilizer feet, by pulling the "LEFT JACK UP/DOWN" and the "RIGHT JACK UP/DOWN" handles toward you, until the bulge is removed from the drive axle tires. Level the vehicle within 5 degrees from side to side, utilizing the level indicator located on the rear of the cab or front of the body.



CAUTION

DO NOT heavily load one stabilizer before the other. This imparts strong twisting loads on the apparatus, which could cause damage. Raised areas such as curbs or sidewalks may cause one jack to be lowered much less than the other.

1. Lower the front axle locks completely by pulling the lever labelled "CAB JACK" until the indicator illuminates green, and the hydraulic jack has stopped moving.



WARNING

Never operate the ladder without first deploying the stabilizer jacks with proper ground pads beneath them.

1. Insert both safety pins into their appropriate holes just behind the front jack stabilizer cylinders. (See fig.2)



CAUTION

Always install safety pins on stabilizers. In the event of a hydraulic failure, they may be necessary to prevent the apparatus from becoming unstable and collapsing.

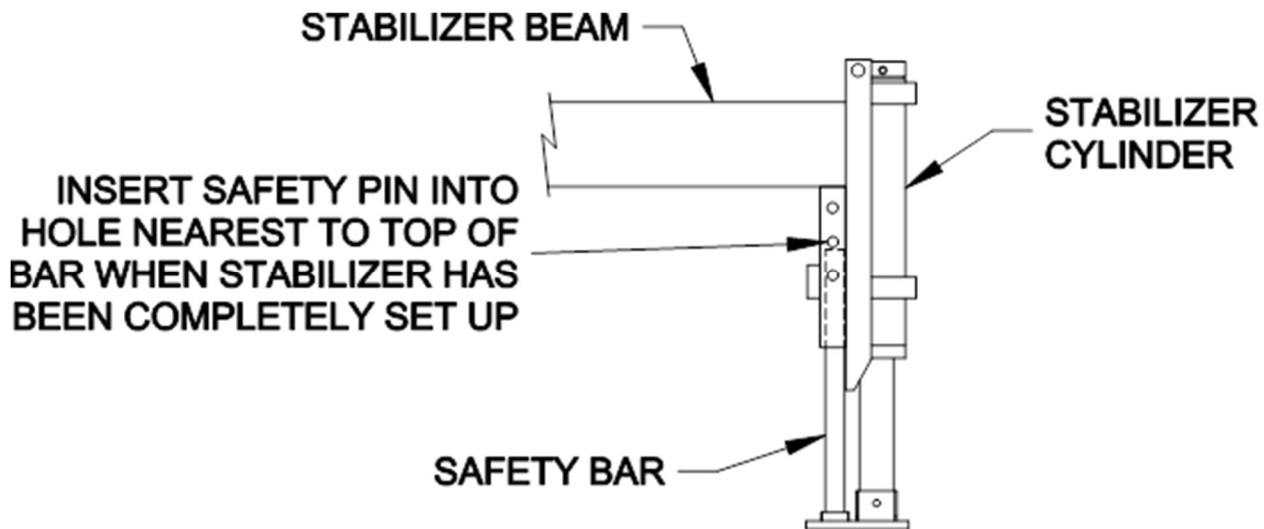

Figure 2- Jack Stabilizer Cylinders



CAUTION

When all prerequisites of the interlock have been met, the audible alarm will stop sounding. If the alarm does not silence, the interlock will not allow operation of the aerial. The interlock requires that:

- (1) The main stabilizers are fully extended.*
 - (2) The safety pins are in place.*
 - (3) The front axle lock has been engaged.*
1. Turn on the "UPPER POWER" switch, located on the aerial control pedestal. This energizes the controls at the ladder pedestal. It also controls the ladder intercom.
 2. Verify with all personnel that the ladder is ready to operate. When stabilizers and ground pads are properly set on stable ground, the ladder is designed to operate at optimum operational height and horizontal reach with rated payload.
 3. Always operate the tower with caution so it does not strike the cab or any other portion of the truck.



1.10 Ladder Operation



CAUTION

The aerial ladder must be operated with respect, discretion, and proper training. The aerial ladder should be operated at low speed when there is not any danger, electric wires, buildings, during close operations, returning to the cradle, and during operation around the apparatus cab or body.



WARNING

Never operate the ladder without first deploying the stabilizer jacks with proper ground pads beneath them.



Figure 3- Ladder Controls At Pedestal

The pedestal contains all of the controls required to operate the aerial ladder. (See fig. 3)

▽ **Operator Manual**

1.11 Ladder Function Controls

Elevation

Raise the ladder by pulling the right control lever toward you.

Lower the ladder by pushing the right control lever away from you.

The ladder can be elevated from minus 5 degrees to plus 75° degrees from the horizontal while in any position given that no obstructions, such as the body or cab, are present.



CAUTION

When moving the ladder from the cradle, the first motion of the ladder should be “Raise”. This should continue until the ladder is well above the apparatus.



DANGER

When raising the ladder, extreme caution must be used near power lines. The operator must observe the ladder structure from base to tip to make sure the ladder is clear.



WARNING

The aerial device is rated for service in winds up to 35 mph.

Extension

Extend the ladder by pushing the left control lever away from you.

Retract the ladder by pulling the left control toward you.



CAUTION

Before retracting the ladder, make sure both waterway drains are open to avoid pressurizing the water in the waterway. Failure to do so can result in serious damage to the waterway. (See section on “Draining the Waterway and Nozzle”)

Rotation

Rotate the ladder clockwise by pushing the center control lever away from you.



Rotate the ladder counterclockwise by pulling the center control lever toward you.
The ladder.

The ladder can rotate a continuous 360 degrees either to the left or to the right. It is recommended that the engine be at idle when rotating.



WARNING

While rotating the ladder, the operator should not change directions before the ladder comes to a complete stop! If the operator accidentally changes rotation direction with the ladder not coming to a complete stop, a built-in relief valve is provided to reduce shock. However, this can still damage or break the rotation gear, in no way should this be an operational practice.



CAUTION

The recommended procedure for ladder operation is a slow, steady movement of the control lever. This will produce a smooth ladder operation. Rapid movement of the control levers will result in rough jerking of the ladder. This will create excessive loading on the ladder structure. This kind of operation is unsafe and will lead to premature wear and possible structure failure.

The hydraulic valve body has built-in relief valves to prevent damage to hydraulic components. If the operator attempts a maneuver that has exceeded the ladder's hydraulic capacity, the ladder will not move. Also, when the function has reached the end of its travel (e.g., the ladder is fully extended), the ladder will stop moving, even if the control handle is not released.



CAUTION

Relief valves are incorporated in the system to prevent damage to components from hydraulic pressure build-up. This does not guarantee that damage will not occur to the aerial while it is in motion! Careless operation, overloading the aerial, and collisions with other objects may allow damage to occur even when the relief valves are properly adjusted. The operator is ultimately responsible for the safe operation of this aerial!

1.12 High Speed Controls



CAUTION

CAUTION MUST BE EXERCISED WHEN USING THE “HIGH SPEED” SWITCH.

The "HIGH SPEED" foot switch is located on the turntable floor next to the pedestal. During ladder operations, this switch increases the engine idle speed to a higher, preset level that, in turn, increases the hydraulic system power available to ladder functions. This option is not available when the apparatus is pumping water.

When using "HIGH SPEED", it is very important that the operation of the controls be performed in the proper sequence. By doing so, excessive loads on the ladder structure will be avoided and a smooth and safe operation will result. This sequence is as follows:

1. Actuate the desired function lever.
2. Push the "HIGH SPEED" foot switch to accelerate the function being operated.
3. When the ladder approaches the desired position, release the "HIGH SPEED" switch.
4. Release the function lever at the desired location.

The aerial ladder must be operated with respect, discretion, and proper training. The aerial ladder should move on low speed when there is any danger, electric wires, buildings, at close operations, returning to the cradle, and during operation around the cab. When the aerial is returned to the cradle, remove jack pins. An electro-hydraulic valve will automatically transfer power from the aerial to the jacks, locking out the aerial ladder functions and allowing jack operation.



DANGER

Operators must install safety pins and locks on stabilizers.

Additional Pedestal Controls & Indicators

In addition to the ladder function controls, there are other switches and indicators on the pedestal. (See fig 3) These are described as follows:

Rung Alignment

The rung alignment light indicates the ladder rungs are aligned for climbing.

For Service Call
1-866-287-5549



Panel Light Switch

The panel light illuminates the control panel for nighttime operation.

Alignment Light

The alignment light indicates when the ladder is aligned with the cradle when stowing the ladder after use. This indicator is used in conjunction with the arrows located on the side of the turntable and the compartment top.

1.13 Ladder Positioning

When positioning the ladder for climbing, it is strongly advised that the tip of the ladder *SHOULD NOT BE RESTED ON OR POWERED DOWN ONTO ANY SURFACE* such as a window ledge or roof. The tip should be placed so that, when loaded, it remains several inches above the desired location. (See fig. 4) This ladder is designed to be loaded with the tip unsupported. Remember -- as personnel climb the ladder, the weight will bring the tip nearer to the surface.

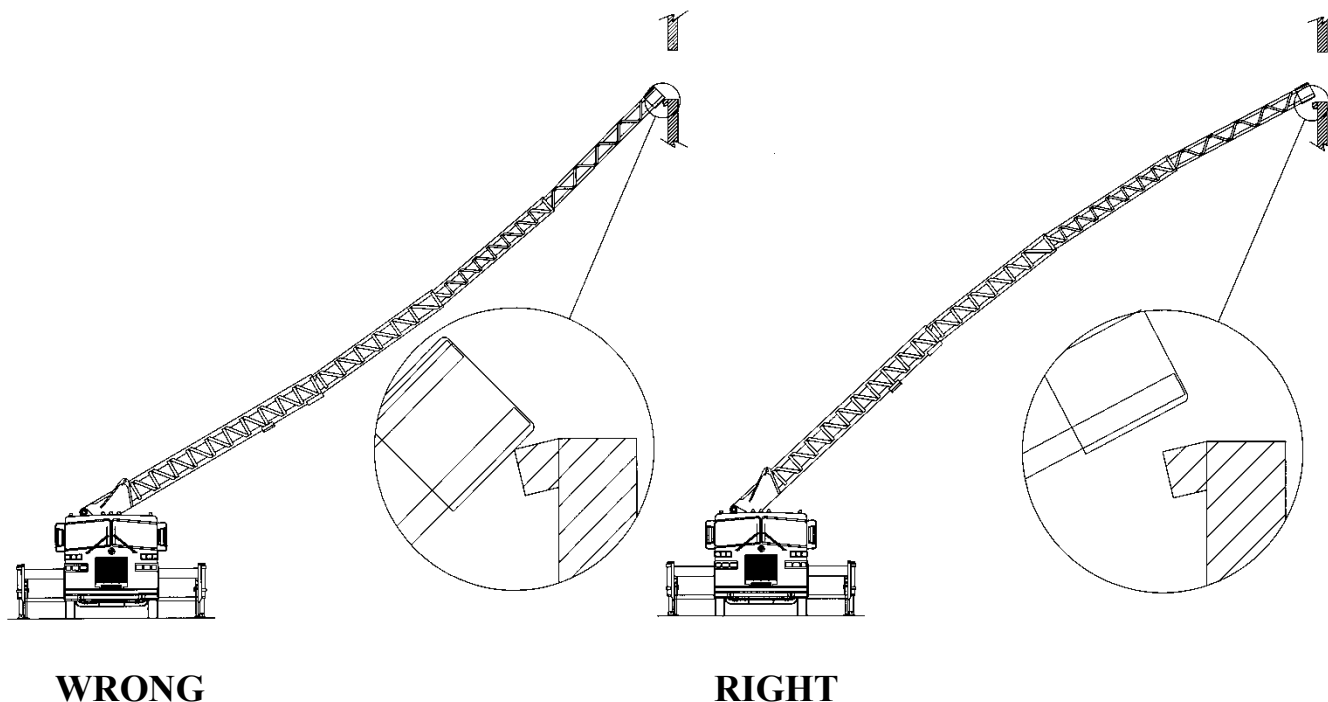

Figure 4- (Ladder Flex Exaggerated For Illustration Clarity)



CAUTION

Reverse loading of the aerial device will cause structural damage, especially at full extension and/or near horizontal elevations. This device is designed to be used with the tip unsupported!

Climbing Ladder or Using as an Escapeway

When climbing the aerial, or when an escape procedure is in progress, close the cover on the pedestal to render the ladder function controls inaccessible. This will prevent any accidental movement of the ladder while it is occupied.

1.14 Auxiliary Hydraulic Power Switch

NOTE: The auxiliary hydraulic power switch is to be used only to place the ladder back into cradle and to raise the jacks - not to be used for normal operations.

The auxiliary hydraulic power switch is located inside the trailer gooseneck. Use the auxiliary hydraulic power switch if a main hydraulic pump fails in the tower or if the truck engine fails. The auxiliary power is an electric motor, operating from the truck battery system which operates the auxiliary hydraulic pump.

Operate the motor by activating the momentary auxiliary power switch.

All tower functions can be operated on auxiliary power.



CAUTION

Prolonged operation may cause the motor to overheat. The operator should avoid overheating and burning out the motor. If the motor becomes hot, shut down and allow it to cool. Failure to do so could result in serious damage to the motor. Run for ten minutes and cool for ten minutes.



1.15 Safety Interlock System

The safety interlock system prevents ladder operation that could result in personal injury or dangerous conditions. The system contains a locking device that locks the transfer valve in the “LADDER” position when the aerial is raised from its bed. This prevents the jacks from being operated while using the ladder. It also includes an electric/hydraulic valve that disables the ladder controls when the stabilizers are not properly deployed. In addition to the interlock, and audible alarm sounds until the stabilizers are set.

NOTE: The stabilizers must be visually checked by the operator or other designated person to make sure the stabilizers and pads are properly set, and safety pins inserted.

The aerial is now ready for operation. The hydraulic transfer valve should have shifted from jack to aerial position, allowing the controls to operate the aerial ladder. The aerial ladder must be operated at low speed when there is any danger, electric wires, buildings, at close operations, returning to the cradle, and during operation around the cab. Return the aerial to the cradle, remove jack pins. The hydraulic circuit will transfer, locking out the aerial ladder functions and allowing jack operation. The aerial ladder must be operated with respect, discretion, and proper training.



WARNING

The stabilizers must be visually checked by the operator or a designated person to make sure the stabilizers and pads are properly set, and safety pins inserted.



CAUTION

Never operate the tower unless the stabilizers and pads are properly set.

1.16 Waterway and Nozzle

Operation and Use

The waterway through which water from the waterway inlet is transferred to the nozzle is a four-section telescopic aluminum device. It is located within the tower sections, mounted, and cushioned to eliminate any undue stress or strain under tower operating conditions. Special seals are provided at the attachment location of each waterway section to ensure constant alignment and eliminate wear to the tubes.

The waterway is fed through the main feed line, located on each side of the vehicle beneath the turntable.

A relief valve is installed in the waterway system to help prevent excessive pressure in the waterway. Should the operator retract the tower without opening the waterway drain or should pump pressure exceed the capacity of the waterway, the relief valve will open. Do not exceed 250 PSI discharge pressure. The waterway drains should always be left open when tower is not being operated.

Maintenance is minor and is described in the AERIAL TOWER LUBRICATION AND SERVICE section.

NOTE: Before retracting the tower, make sure the nozzle and the waterway drains are open to avoid compressing the water in the waterway. Failure to do so can result in serious damage to the waterway.

Draining of Waterway and Nozzle

1. Open the waterway supply valve completely. (this may be on a separate vehicle)
2. Open all nozzles and/or valves at fly end of ladder.
3. Open waterway drain valves.
4. Raise ladder to at least 40 degrees.



-
5. After all water has drained out, go to step #6.
 6. Fully extend ladder.
 7. Lower ladder off the side of truck at below grade angle.
 8. Wait until water has drained completely from nozzle and drain.
 9. Retract ladder and return to cradle.

NOTE: These steps must be followed in the above order to completely drain the waterway and all nozzles. This will prevent freezing the waterway in cold weather and damaging the waterway when retracting.

NOTE: Waterway drain valves must be carried in the open position when water tower is not being used.

1.17 Optional Breathing Air System

If a life support breathing system is installed on the aerial tip. This system has an air cylinder mounted in brackets on the ladder turntable, a shut-off valve, and a constant flow air regulator.

Air is piped from the regulator by a heavy-duty air hose through an air reel, located in the base section of the tower.

At the ladder tip, there are air connections available to connect fire department breathing air apparatus.

Air to the connections can be regulated from the air supply cylinder by presetting the regulator at approximately 80 PSI. Once the air pressure is regulated, as required by the operator, turn the air on at the air cylinder valve to provide air to the tip. The air valve should always be turned off when not in use. An air drain valve is provided on the bottom of the filter and should periodically be opened briefly to expel any moisture that may be

▽ **Operator Manual**

captured in the filter. Use of the air system should be determined by the personnel using the aerial device.

1.18 Return Aerial to Travel Position

Retract the Tower

Retract the tower fully by pulling the left control lever, located at the control box, toward you.

NOTE: If the waterway has been used before retracting the tower, the nozzle and waterway drains must be open to avoid compressing the water in the waterway. Allow enough time for the waterway to drain before retracting the tower. Failure to do so can result in serious damage to the waterway.

Lower the Tower

NOTE: This function should only be performed with the engine speed at idle.

Lower the ladder fully by pushing the right control lever away from you. After the tower is lowered into the cradle, continue to hold the control lever in the lower position for a few seconds. This will pressurize the lift cylinders in the “down” direction. The holding valves in the cylinders will maintain this pressure, effectively locking the ladder in the cradle for travel.

NOTE: The monitor must be stowed in the horizontal position to avoid damage from interference with the body.

Remove Wheel Chocks

NOTE: Always remove the wheel chocks before releasing the stabilizers. Failure to do so could result in wedging the chocks tightly against the tires making them unremovable. Remove safety pins on stabilizers.



Retract the Stabilizers

1. Turn off the “UPPER POWER” switch located on the aerial control pedestal.
2. Remove jack pins and stow in their holders just behind the front stabilizer cylinders.
3. Move to the lower operator’s position for the hydraulic system.
4. Raise the front axle locks completely, by pushing the “CAB JACKS” handle away from you.
5. Raise the stabilizer feet completely, by pushing the “LEFT JACK UP/DOWN” and the “RIGHT JACK UP/DOWN” handles away from you.

NOTE: Do not unload one stabilizer before the other. This imparts strong twisting loads on the apparatus, which could cause damage.

6. Retract the main stabilizers completely by pushing the handles marked “LEFT JACK IN/OUT” and “RIGHT JACK IN/OUT” away from you.



WARNING

Exercise caution when retracting the opposite side stabilizer, taking care to watch it closely as it is retracted. Always use a spotter when available!

7. Return the ground pads to their stowages.
8. Make sure the engine is at idle R.P.M.
9. Enter the cab.
10. Move the PTO switch from “IN” to “OUT” position. Make sure the red PTO indicator light goes out.
11. Enter the cab and disengage the fire pump, if used.
12. Shift transmission to neutral.

▽ **Operator Manual**

13. Wait until the speedometer registers "0" miles per hour.
14. Pause for three seconds.
15. Move pump shift lever from "pump" position to "road" position.
16. Release the parking brake.
17. Place transmission in appropriate gear (Drive 1-4 or Reverse).



CAUTION

Exercise caution when retracting the opposite side stabilizer, taking care to watch it closely as it is retracted. Always use a spotter when available!



WARNING

All personnel must be seated, and seat belts fastened before the unit is moved.



WARNING

Never back the truck unless a guide has been placed at the rear of the truck, giving clear signals to the operator. If the guide disappears from view, the movement must be stopped until the guide appears.



Chapter 2 Maintenance Manual

	<u>Page</u>
2.6 Aerial Maintenance.....	2-2
<i>Stabilizers</i>	2-2
<i>Main Lift Cylinders</i>	2-2
<i>Pivot Shaft Bearings</i>	2-2
<i>Turntable Bearing</i>	2-3
<i>Rotation Gear Reducer</i>	2-3
<i>Drive Gears</i>	2-4
<i>Sheaves</i>	2-4
2.7 Extension System.....	2-4
<i>Cable Adjustment Procedure</i>	2-4
<i>Slide Blocks</i>	2-8
<i>Waterway and Seals</i>	2-8
2.8 Water Lubrication Procedure.....	2-9
<i>Waterway Nozzle</i>	2-10
<i>Waterway Pinning Level</i>	2-10
<i>Hydraulic Oil Tank</i>	2-11
<i>Hydraulic Tank Fill Instruction</i>	2-12
2.9 Return Oil Filtration System.....	2-13
2.10 Maintenance of Structure.....	2-13
<i>Aluminum Tower Structure</i>	2-13
<i>Turntable Attachments</i>	2-13
<i>Aerial Tower Lubrication and Maintenance Schedule</i>	2-15
<i>Torque Specifications</i>	2-16
<i>Walk-Around Check for Mobile Fire Apparatus</i>	2-17

2.1 Aerial Maintenance

Stabilizers

When the stabilizers are extended completely to the ground, an area of the inner sleeve becomes exposed. This area should be periodically coated with a light film of grease, such as Pro-One EP2. Visually check safety pins and locks.

Main Lift Cylinders

The main lift cylinders are located on each side of the main base section of the tower assembly. Each cylinder has two (2) lube points. One (1) lube point is on the rod end where the rod eye attaches to the side plate of the tower assembly. One (1) lube point is on the bottom end where the cylinder is attached to the turntable. At each point, a grease fitting is installed. These points should be lubricated with a good grade of Pro-One EP2 Grease every 25 hours of operation, or annually, whichever comes first.

Pivot Shaft Bearings

There are two (2) pivot shaft bearings located on top of the upper assembly side plates, one on each side, which rotate on the pivot shaft. The pivot shaft is permanently attached to the turntable side plates on the outside of the side plates. Grease fittings are installed on the pivot shaft bearings. These bearings need to be lubricated with a good grade, Pro-One EP2 Grease every 25 hours of operation, or annually, whichever comes first.

Turntable Bearing

The bearing and drive gear assembly is located directly under the turntable. The entire turntable and tower assembly rotates on this bearing. This bearing is pre-lubricated at the factory with a Pro-One EP2 Grease. Grease fittings are provided on the inside of the bearing accessible through the top of the upper assembly. Lubrication should be done three (3) months after delivery, then annually. Use Pro-One EP2 Grease.



NOTE: At this time, we recommend all bolts attaching the turntable to the bearing, and all bolts attaching the bearing to the main frame should be checked for tightness. SEE TURNTABLE ATTACHMENTS, page 2-16.

Rotation Gear Reducer

This device rotates the turntable and tower assembly. It is located on top of the turntable.

It is driven by a hydraulic motor, directly attached to the high-speed worm gear shaft. No lubrication is required for the hydraulic motor. On the main gear case, there are three (3) plugs, located on the right-hand outboard side. The top plug is the oil fill vent plug. The one on the side is the fill level plug. The bottom one is the drain plug.

Under normal tower operation conditions, the lube oil in this gear reducer needs to be changed three (3) months after the delivery date of the tower. Thereafter, lube oil needs to be changed every (12) months (average 4 hours per day operation). Never over fill the unit. Check oil level every three (3) months. Use a good grade of 140 weight gear lube oil. At the upper portion of the main gear case, there is a grease fitting. This fitting needs to be greased every 25 hours of operations, or annually, with a good grade of EP bearing grease.

There are three (3) plugs on the primary rotation gear housing. The one on top (1/4") is the filler-breather plug. The one on the side (1/4") is the lube level plug. The one in the bottom of the high-speed gear housing (1/4") is the drain plug.

Maintain oil level to Oil Level plug. Check the oil level every three (3) months. Use a good grade of 140 weight gear lube oil.

Drive Gears

The drive pinion gear and the turntable bearing gear are lubricated with a special elastic lube, designed to endure the life of the unit.

Sheaves

There are sheaves and cables which is part of the tower extension/retraction system from the second section up. Each sheave has a bearing and requires periodic lubrication. In the sheave bearing pin, there is a grease fitting provided. Each sheave needs to be greased every 25 hours of service, or annually. Pro-One EP2 Grease is recommended.

When servicing the sheaves, the tower should be extended horizontally to maximum position and the cables wiped free of any dirt and/or grime with a slightly moist Naphtha cloth. Then, lubricate with a thin film of oil. Oil on a cloth permits this to be done easily and adequately.



DANGER

Stabilizers must be set before performing this operation.

2.2 Extension System

Cable Adjustment Procedure

Before beginning cable adjustment, be aware that this adjustment not only affects the tension of the cables, but also the position of the ladder section rungs. Follow the steps outlined below to maintain rung alignment throughout all sections as the cables are adjusted.

1. Set up aerial device according to the operator's manual. Make sure the waterway is empty and there is no extra weight on the aerial.



2. When the rung alignment indicator is illuminated, these rungs will always be aligned. Higher aerial sections, however, rely on proper cable adjustment to maintain alignment.
3. Raise the aerial to 45 degrees and rotate to one side of the apparatus. Position the aerial at, or slightly above zero degrees, so the cables below rung level can be serviced from the ground. With the aerial fully retracted, measure the gaps between each aerial section. The gap between Sections 1 and 2 is set by the cylinder connection and cannot be adjusted. Make sure there is a gap of ¼"-2" between sections two and three. Between the third and fourth sections, this gap should be between 5 ½" - 6 ¼". If you do not have the required spacing, then make the following adjustments.
 - a. Fully extend the aerial. Be sure the aerial tip does not touch the ground.
 - b. Measure the distance between sections 2-3 and 3-4. It should be 252 inches (+/-1/2) for model SLTDA 105.
 - i. If it is less than 251 ½" -Loosen the retract cables. To loosen the cables, you must first loosen the cable rod lock nut, and then loosen the adjustment nut. Retract the aerial approximately 12 inches to release tension from the extend cables. Tighten the extend cables. Repeat this process as necessary to achieve the prescribed dimension on all sections. Retighten all lock nuts, then fully retract the ladder and re-check the spacing between the sections.
 - ii. If it is greater than 252 ½"- Retract the ladder approximately 12 inches, then loosen the extend cables. To loosen the cables, you must first loosen the cable rod lock nut, and then loosen the adjustment nut. Extend the aerial completely, then tighten the retract cables. Repeat this process as necessary to achieve the prescribed dimension on all sections. Retighten all lock nuts, then fully retract the ladder and re-check the spacing between the sections.
 - c. Once the proper spacing is achieved, proceed with the adjustment procedure.
4. Assure the aerial slide areas and the waterway are clean and well-lubricated.

 **Maintenance Manual**

5. Inspect all cables for kinks, wear, and any signs of damage. Lubricate cables and sheaves. Extend and retract ladder as needed to reach all components.
6. Fully extend ladder, keeping the tip clear of the ground. Make a mark on the 2nd ladder section, 24 inches from the base section. Retract the ladder 24 inches, until the mark is at the edge of the base section.
7. Measure to the center of exposed length of the 2nd section approximately 114 inches from the base section and make a mark. At this mark, measure the distance from the bottom of the aerial section to the top of each cable. The measurement should be taken with the cable hanging free, without pulling down on it. Both measurements should be 1 ½ inch (+/- 1/8 inch), and the pair should be equal. If not, adjust the cables as follows.
 - a. Loosen the cable rod locknut and tighten or loosen the adjusting nuts, retighten the locknut. With the lock nut re-secured, if more than 2” of cable rod end is exposed, contact the factory service department before proceeding.
8. Measure to the center of the 3rd section, approximately 114 inches from the base section and make a mark. At this mark, measure the distance from the bottom of the aerial section to the top of each cable. The measurement should be taken with the cable hanging free, without pulling down on it. Both measurements should be 7/8 inch (+/- 1/8 inch), and the pair should be equal. If not, adjust the cables as follows.
 - a. Loosen the cable rod locknut and tighten or loosen the adjusting nuts, retighten the locknut. With the lock nut re-secured, if more than 2” of cable rod end is exposed, contact the factory service department before proceeding.

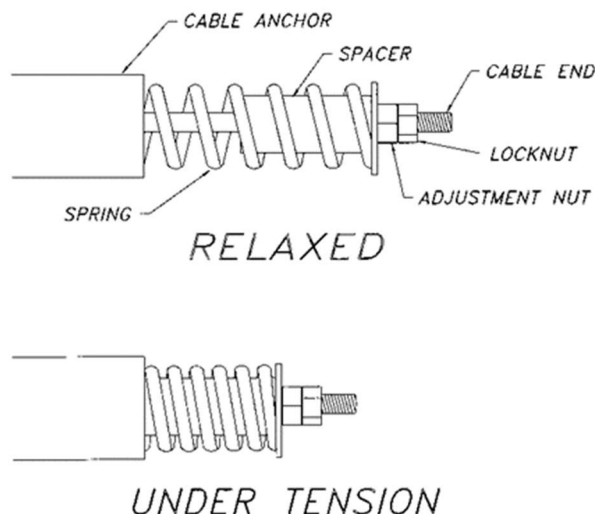

9. Operate the ladder throughout the extend and retract strokes. (Remember there will always be some slack in the cables not doing the work of the function performed. i.e., there will be slack in the retract cables when extending the ladder.)
10. Stop the ladder when the rung alignment indicator illuminates. Check the position of the third ladder section rung alignment. If the third section rungs are running behind the second section rungs, the third section retract cables should be loosened and extended cables (which hang below the second aerial section) tightened. Adjust as necessary. Be sure the third section rung position is satisfactory before moving on to the fourth section.
11. Again, operate the ladder throughout the extend and retract strokes. Stop the ladder when the rung alignment indicator illuminates. Check the position of the fourth ladder section rung alignment. If the fourth section rungs are running behind the third section rungs, the fourth section retract cables should be loosened and extend cables (which hang below the third aerial section) tightened. Adjust as necessary.
12. When adjustment is complete, operate the ladder throughout the extend and retract strokes at different angles of elevation
 - a. It is important to remember there will always be a certain amount of slack in the cables, not pulling the ladder sections. At high angles of elevation, the extend cables will always have tension, even while retracting the ladder.
 - b. The ladder sections should move smoothly, with all sections moving simultaneously. Sections should not drift back when the ladder is elevated,

beyond the compression of the tensioning springs. At no time should the sections collide while retracting.

13. With the aerial fully retracted, recheck spacing gaps between sections.

Slide Blocks

These devices are attached to the ends of the tower at both the upper and lower positions on each section. There are 24 slide blocks in the tower. They support each section of the tower, so no metal-to-metal contact occurs.

The material is "UHMW POLYETHYLENE" compound. It is designed to withstand heavy loading. Lubrication is required in the path in which the slide blocks travel on each section. The slide block paths are lubricated at the factory with Pro-One EP2 Grease. The slide block path lubrication needs to be checked every 25 hours of operation, or annually. Any bare spots should be cleaned, and Pro-One reapplied.

There are exceptions to this schedule that should be considered. Should the tower be operated at a fire and exposed to excessive dirt and grime, it is recommended that the slide block travel paths be cleaned, and the lubricant be reapplied.

Waterway and Seals

This is the telescopic tube device inside the tower which carries the water to the tower nozzle. It has seals which ride on the internal honed surface of the tubes. These seals are made with an impregnated lubricant. In cases when the tower is operated many times without pumping water through the waterway, it is necessary to provide additional lubrication to the seals through the waterway. The procedure is as follows:



DANGER

Never extend or move the tower in any way while persons are on the tower. The person oiling the waterway should wear a life belt while on the tower.



DANGER

Stabilizers must be set before performing this operation. Never extend or move the ladder in anyway while persons are on the ladder. The person oiling the waterway should wear a life belt while on ladder.

NOTE: Remove nozzle prior to raising the ladder to avoid destroying it if dropped accidentally.

This service should be done following any extensive use of the tower without pumping water, or monthly. The outsides of the tubes are provided with nylon bearing collar assemblies built into the mounting collar of each section. The outside of these tubes should be kept free of dirt and grime to protect the bearing collars.

Should the tower be used under extremely dirty conditions, the waterway should be wiped off promptly with Naphtha or similar solvent to assure that the surface of the tubes are free of abrasive particles.

2.3 Waterway Lubrication Procedures

1. Set up truck for tower operation.
2. Raise and rotate ladder off the side of truck.
3. Fully extend ladder out.
4. Use a clean towel and wipe off the outer sections of the waterway tubes.
5. Apply Dex/Merc Transmission Oil to a clean towel and wipe the oil on the entire length of each waterway tube, except for the main outside large tube.
6. Apply Pro-One EP2 Grease at each grease point on each waterway section.
7. Retract ladder fully and return ladder to cradle.

Waterway Nozzle

NOTE: Refer to Nozzle Manufacturer's instructions for more detailed information.

The gears must be kept greased at all times. Low-Temp Lubriplate grease should be applied to the grease fittings annually. Grease should be applied until visible through the swivel plugs.

Waterway Pinning Lever

The waterway pinning lever should be checked regularly for proper operation. With the aerial fully retracted, remove the pin, and move the lever to the 3rd or 4th section position. Confirm the pinning hooks fully engage and then return the lever to the original position and re-insert the pin.

If the waterway pinning lever does not move freely, this may be a sign that cables need adjusted. Refer to the CABLE ADJUSTMENT PROCEDURE section of the manual.

Hydraulic Oil Tank

The hydraulic reservoir, located behind the tractor cab, has a capacity of 54 gallons. The hydraulic oil furnished in your aerial tower hydraulic system is filtered Dex/Merc hydraulic oil. Ensure the new hydraulic fluid is filtered to ISO code 22/18/13.



CAUTION

When checking or adding oil, make sure all hydraulic systems are at rest (retracted). Failure to do so will result in overfilling the system.



The hydraulic oil filters should be changed after the first three (3) months of service and changed annually thereafter.

This is done as follows:

1. Shut off oil to filter at tank valve.
2. Remove the filter.
3. Inspect oil in the filter. Do this by using a piece of clear glass, a white cloth or piece of paper, and pouring some of the oil in the filter onto it. This way any dirt, filings, and moisture can be observed.
4. Replace the filter.



CAUTION

There are three filters in the hydraulic system, one located in the reservoir lid (6 micron), one in the high-pressure portion of the system (6 micron), and one at the fill location (3 micron). Each must be replaced in kind. Failure to do so could result in damage to the hydraulic system or cause poor operation of the tower.

NOTE: All hydraulic cylinders and actuators, except cab lift, must be in the retracted position (i.e., travel position).

Hydraulic Tank Fill Instruction

1. Locate the top off/filtration unit (TOFU) suction hose supplied with the vehicle, the Hydraulic Tank Fill port, and the Hydraulic Tank Fill switch.
2. Locate the Fill Level Dip Stick on top of the Hydraulic Fluid Reservoir.
3. Check the current oil level. Proceed only if it is below the full level (line on dip stick). If it is at, or above the full mark, the system is full. Replace the dip stick.
4. Remove the rubber Hydraulic Fill Port plug; by pushing in the quick connect lock ring and pulling the plug out of the port.
5. Remove the plug from the inlet side of the suction hose.
6. Insert the quick connect end of the suction hose into the fill port.

Maintenance Manual

7. Connect or submerge the inlet side of the suction hose to/into a container of Dex/Merc hydraulic fluid.
8. Lift the red safety cover over the Hydraulic Tank Fill switch and move the switch to the up position.
9. Activate the Aux. Motor switch for 30 seconds. This will draw approximately ½ gallon fluid from the container.
10. Check the fluid level in the reservoir.
11. If the fluid level is below the full level, repeat steps 9 and 10. Adjusting the time as necessary.



CAUTION

DO NOT run the Aux. Motor for more than 10 minutes.

12. When the fluid level reaches the full level (approximately 2” from the top); push the Hydraulic Tank Fill switch red safety cover down. This will turn the switch off.
13. Remove the suction hose from the Hydraulic Tank Fill port, and securely replace the rubber plug.
14. Drain the remaining fluid in the suction hose back into the fluid source and replace the metal plug.

2.4 Return Oil Filtration System

The return filter is fitted with a bypass indicator. Change this filter if the By-Pass indicator is going into the red. This must be observed when the unit is in operation. With the unit fully set up at high idle observe the bypass indicator when running retract and lower at the same time. This is the highest flow rate the filter will see. Otherwise change this filter after the 1st 50 hours of operation and 250 hours thereafter.



Replace with MP Filtri original equipment element # CSG100A06A. The KFS4596-C reservoir assembly is fitted with a Dipstick. This reservoir is full with all stabilizers and the aerial stowed at 2-3" from the top of the tank. Hydraulic fluid should be replaced every 500 hours of operation or one year of operation, whichever comes first. Ensure the new hydraulic fluid is filtered to ISO code 22/18/13. New oil from the refinery or oil distributor has not been filtered to this ISO code, it is typically 24/22/20.

2.5 Maintenance of Structure

Aluminum Tower Structure

The tower structure members are #6061-T6 aluminum alloy extrusion. This alloy is very resistant to corrosion and requires very little maintenance. Periodic washing with clear water only is recommended. Use mineral spirits for removal of tar, oil, and smoke film. If a brighter appearance is desired, use any quality automotive polish, a mag and aluminum wheel cleaner, or a Scotchbrite pad.



CAUTION

DO NOT use any alkaline (base) polishes.

Turntable Attachments

The bolts attaching the turntable assembly to the rotation bearing are 3/4-10 NCX 4 1/2" long, grade 8. Should replacement be necessary, they must be replaced with an equivalent bolt (contact Sutphen Towers, Inc. for detailed requirements).

There are 36 bolts on the turntable. These bolts have an SAE hardened washer and should be kept tightened to a dry torque of 270-300 ft. lbs. This torque should be checked every three (3) months.

There are 32 bolts attaching the rotation bearing to the support structure. They are 3/4-10 NC X 4 1/2" long-grade 8 with an SAE hardened washer under the head.

▽ **Maintenance Manual**

These assemblies should be kept tightened to a dry torque of 270-300 ft. lbs. and should be checked every three (3) months. The heads of these bolts are accessible through two 3" diameter holes in the turntable plate. The turntable must be rotated for access to check all bolts.

Any indication of loosening or bolt failure should be reported to Sutphen Towers, Inc., for evaluation and recommendations.



CAUTION

The person operating the turntable for bolt alignment must make sure all persons and tools are free and clear before rotating turntable.

NOTE: Sutphen recommends that once a week the ladder should be raised to full elevation, full extension, then rotated completely 360 degrees in both directions.



AERIAL TOWER LUBRICATION AND MAINTENANCE SCHEDULE

LUBRICATION POINTS	LUBRICANT	INTERVAL	MONTHLY	ANNUALLY
STABILIZERS	Pro-One EP2 Grease	AS NEEDED OR		X
MAIN LIFT CYLINDER	Pro-One EP2 Grease	25 OPERATING HOURS OR		X
PIVOT SHAFT BEARING	Pro-One EP2 Grease	25 OPERATING HOURS OR		X
TURNTABLE BEARING	Pro-One EP2 Grease	FIRST 3 MO. THEN		X
DRIVE GEAR	None Required			
ROTATION GEAR	140 wt. Gear Oil	3 MONTHS AFTER DELIVERY THEN: AS NEEDED OR		X
EXTENSION-RETRACTION CYLINDER(S)	Pro-One EP2 Grease	EVERY 6 MONTHS OR		X
SHEAVES AND CABLES	Pro-One EP2 Grease-sheaves Dex/Merc-cables	25 OPERATING HOURS OR		X
SLIDE BLOCKS	Pro-One EP2 Grease	25 OPERATING HOURS OR	X	X
WATERWAY AND SEALS	30 wt. Non-Detergent Motor Oil or Dex/Merc Pro-One EP2 Grease		X	
WATERWAY NOZZLE	Pro-One EP2 Grease			X
AERIAL POWER CABLE	Dow #4 Silicone Grease	AS NEEDED OR		X
HYDRAULIC OIL	Dex/Merc	ADD AS NEEDED		2 YRS.
HYDRAULIC OIL FILTER(S)	None Required	CHANGE AT 50 OPERATING HOURS or FIRST 3 MONTHS (whichever comes first) THEN		X

Maintenance Manual

TORQUE SPECIFICATIONS

ITEM	TORQUE	INTERVAL	MONTHLY	ANNUALLY
#1. TURNTABLE TO ROTATION BEARING	250-300 FT. LBS.	FIRST 3 MO. THEN		X
#2. ROTATION BEARING TO SUPPORT STRUCTURE	250-300 FT. LBS.	FIRST 3 MO. THEN		X
#3. ROTATION GEAR MOUNTING (WINSMITH BOLTS)	100 FT. LBS.	FIRST 3 MO. THEN		X
#4. WATERWAY MOUNT BOLTS	45 IN.LBS. (DRY)	FIRST 3 MO. THEN		X
#5. CYLINDER MOUNT BOLTS	35 FT. LBS.	FIRST 3 MO. THEN		X
#6. CABLE ADJUSTMENTS	-----	FIRST 3 MO. THEN	X	
#7. SHEAVE BEAM BOLTS	35 FT. LBS.	FIRST 3 MO. THEN		X
#8. SLIDE BLOCK BOLTS	SNUG	FIRST 3 MO. THEN		X
#9. FRONT JACK CYLINDER BOLTS	500-600 FT. LBS.	FIRST 3 MO. THEN		X
#10. EXTENSION CYLINDER BOLTS	50 FT. LBS.	FIRST 3 MO. THEN		X

**WALK-AROUND CHECKS
FOR MOBILE FIRE APPARATUS**

Fire Department Name:	Date:	Special Instructions:
Truck Model:	HS #:	
Truck Number:	Station #:	
Start Mileage:	Start Engine Hours:	
End Mileage:	End Engine Hours:	

Legend: Rec Min. = Recommended Minimum Interval for Inspection

OPERATIONS	Daily	Weekly	Monthly	6 Months	Annual
Engine – Tilt Cab – Make sure safety prop is engaged and there are no obstructions on the bumper or in the cab.					
1. Check engine oil and transmission level. Check for leaks (see Manual).	Rec Min.				
2. Check engine coolant level – sight glass. Check for leaks.	Rec Min.				
3. Check for integrity of frame and suspension, as well as motor assembly and mount. Check for loose bolts.			Rec Min.		
4. Check power steering fluid level and look for leaks in the fitting or hoses. Transynd	Rec Min.				
5. Check belts for tightness and wear.	Rec Min.				
6. Check steering shafts.			Rec Min.		
7. Check for exhaust leaks. Check heat shields are in place.			Rec Min.		
Outside					
1. Check for fluid leaks under vehicle.	Rec Min.				
2. Check steering shafts and linkages.			Rec Min.		
3. Check wheels and lug nuts for tightness.			Rec Min.		
4. Check tire condition. – Tread Depth. (wear/damage)	Rec Min.				
5. Check tire air pressure.	Rec Min.				
6. Verify all warning label & placards are in place (see Manual).		Rec Min.			
7. Check driveline U-joints and slip joints. Lubricate if necessary. Check for tightness on all universal bolts. Visual check.			Rec Min.		
Cab – lower cab					
1. Check seats and seat belts (damage/warning system) and ensure working properly.	Rec Min.				
2. Start engine, check all gauges, switches, & controls.	Rec Min.				
3. Check windshield wipers & washer fluid level check	Rec Min.				
4. Check rear view mirrors adjustment and operation. R & L	Rec Min.				
5. Check horn, air horn, siren and backup alarm.	Rec Min.				
6. Check all gauges for correct reading after start. Fuel Level Check.	Rec Min.				
7. Check cab glass and mirrors.	Rec Min.				
Body					
1. Check steps and running boards. (damage/loose hardware)	Rec Min.				
2. Check body condition. (doors/latching)	Rec Min.				
3. Check grab handles. (Hardware tight secure)	Rec Min.				
Electric					
1. Check battery voltage and charging system voltage, 13 +VDC.	Rec Min.				
2. Check all lights (ICC and warning); headlights.	Rec Min.				

OPERATIONS	Daily	Weekly	Monthly	6 Months	Annual
3. Check operation of battery charger and receptacle.	Rec Min.				
Brakes					
1. Check the air system for proper air pressure. (See tech manual)	Rec Min.				
2. Check parking brake operation.	Rec Min.				
3. Check air compressor operations. Cut in _____ Cut out _____	Rec Min.				
4. Check hoses or lines for rubbing.			Rec Min.		
5. Drain wet air tank to make sure air dryer is working properly			Rec Min.		
Pump					
1. Operate pump, check pump panel engine gauges.	Rec Min.				
2. Check pump for pressure operation.	Rec Min.				
3. Check discharge relief or pressure governor operation.	Rec Min.				
4. Check all pump drain valves.		Rec Min.			
5. Check all discharge and intake valve operation.		Rec Min.			
6. Check pump and tank for water leaks.		Rec Min.			
7. Check all valve bleeder/drain operation.		Rec Min.			
8. Check primer pump operation.			Rec Min.		
9. Check system vacuum hold.			Rec Min.		
10. Check water tank level indicator.	Rec Min.				
11. Check primer oil level (if applicable).		Rec Min.			
12. Check transfer valve operation (if equipped).			Rec Min.		
13. Check booster reel operation (if equipped).		Rec Min.			
14. Check all pump pressure gauge operation.	Rec Min.				
15. Check all cooler valves.			Rec Min.		
16. Check for oil leaks in pump area.	Rec Min.				
17. Check oil level of pump transmission.			Rec Min.		
18. Check hour meter operation (If equipped)	Rec Min.				
19. Check operation of valve linkage.	Rec Min.				
20. Check ball valves for leaks.		Rec Min.			
21. Check drain valves.		Rec Min.			
Generator					
1. Operations – Hydraulic, Gas, or Diesel	Rec Min.				
2. Fluid levels	Rec Min.				
3. Breakers, Receptacles, lighting for operations		Rec Min.			
4. Voltage Reading, 240V AC		Rec Min.			
Amp Reading		Rec Min.			
HTZ Reading, 60HTZ		Rec Min.			
Aerial Device					
1. Visually inspect aerial structure, slide blocks, cables, sheaves, lacing bolts/ huck bolts and any moving assembly.		Rec Min.			
a. Sheaves – lubed and look for signs of wear		Rec Min.			
b. Slide blocks – all in place (no visible signs of excess wear or damage)		Rec Min.			
2. Check aerial operation – all controls, bucket & pedestal.		Rec Min.			
3. Elevation cylinder, check for leaks & wiper seal (check RAM for pits and/or damage).		Rec Min.			
4. Extension cylinder, check for leaks & wiper seal (check RAM for pits and/or damage).		Rec Min.			
5. Lines & hoses – check for leaks and cuts.		Rec Min.			
6. Check aerial hour meter operation and record hours.		Rec Min.			

OPERATIONS	Daily	Weekly	Monthly	6 Months	Annual
7. Check breathing air system.		Rec Min.			
8. Cable adjustment not too tight and not to lose check all cables and sections. Review tolerance. (See directions in manual)			Rec Min.		
9. Observe operation of cable track system check for debris and/or damage.		Rec Min.			
Waterway					
1. Check waterway system operation, alignment, and check for damage.		Rec Min.			
Hydraulic System					
1. Check aerial hydraulic fluid level. Dex/Merc		Rec Min.			
2. Check high pressure filter under load to ensure it is still in the green and not in bypass as well as return the filter.		Rec Min.			
3. Turn on auxiliary hydraulic power pump – check operation.		Rec Min.			
Turntable					
1. Operate aerial hydraulics + PTO operation (check for leaks or damaged hoses). Verify Indicator Light is functional.		Rec Min.			
2. Rotation		Rec Min.			
3. Rotation hydraulic swivel, check for leaks		Rec Min.			
4. Lines and hoses (for leaks & cuts)		Rec Min.			
5. Pivot pin bolts tight on boom to turn table pivot bearing plate (Heal Pin).			Rec Min.		
6. Check manual overrides.			Rec Min.		
7. Check cradle alignment light and mounting.		Rec Min.			
8. Check pinion and rotation bearing (Winsmith/rotation drives).			Rec Min.		
Turntable Components or Hydraulic Compartment					
1. Safety signs			Rec Min.		
2. Communication system or intercom		Rec Min.			
3. Interlock systems - operational		Rec Min.			
4. High-speed button operational		Rec Min.			
Platform/Bucket					
1. Leveling cylinders, leaks and wiper seal		Rec Min.			
2. Lines and hoses, cuts & leaks		Rec Min.			
3. Check operation of high speed.		Rec Min.			
4. Check operation of intercom system		Rec Min.			
Platform/Bucket (continued)					
5. Check breathing air system in platform - check for leaks and hose condition		Rec Min.			
6. Inspect monitors/turret for operation		Rec Min.			
7. Verify cab avoidance system is operational		Rec Min.			
8. Verify bucket leveling system is operational		Rec Min.			
9. Verify all accessories are secure in the platform		Rec Min.			
Structural Fasteners - See Manual for Reference					
1. Turntable mounting bolts - visual check for tightness				Rec Min.	
2. Chassis Suspension system bolts – visual check for tightness				Rec Min.	
Stabilizers					
1. Check aerial outrigger operation		Rec Min.			
2. Check aerial jack & rotation interlocks for operation		Rec Min.			
3. Indicator lights working		Rec Min.			
4. Jack pads in proper location & serviceable		Rec Min.			
5. Mounting bolts – visual check for tightness		Rec Min.			
6. Verify safety lock pins operation in aerial jacks and in location		Rec Min.			

OPERATIONS	Daily	Weekly	Monthly	6 Months	Annual
7. Cylinders – check for leaks & wiper seals		Rec Min.			
8. Control valve – smooth operation		Rec Min.			
9. Lines & hoses – check for leaks and cuts		Rec Min.			
10. Diverter valve – check for leaks		Rec Min.			
Lubrication					
Grease Parts and Assemble as Required per the Trucks Maintenance Manual:					
1. Sheaves - Min. Wkly or more if hours of operation dictate		Rec Min.			
2. Cables, wipe down with oil, Dex/Merc		Rec Min.			
3. ProOne Grease on boom section, Review and add where needed per manual		Rec Min.			
4. Rotation gear and bearing				Rec Min.	
5. Rotation gear reduction box				Rec Min.	
6. Extension cylinder pins, grease pivot				Rec Min.	
7. Stabilizer extension cylinder pins				Rec Min.	
8. Aerial waterway pipe sections, wipe with Dex/Merc		Rec Min.			
9. Grease turret guns		Rec Min.			
10. Lightly apply Dex/Merc to Cable trough sections - Do Not Over Apply		Rec Min.			
Indicators					
1. Validate rung alignment operation; pedestal and bucket		Rec Min.			
2. PTO engaged in cab		Rec Min.			
3. Aerial alignment light for cradle bedding		Rec Min.			
4. Elevation/inclometer in bucket		Rec Min.			
5. Inclometer in turntable area for truck level.		Rec Min.			
Comments:					



Chapter 3 Warranty

	<u>Page</u>
Aerial Platform or Aerial Ladder Structural and Corrosion Warranty Thirty (30) Years.....	3-2
Aerial Platform and Aerial Ladder Mechanical Warranty Two (2) Years.....	3-3



AERIAL PLATFORM OR AERIAL LADDER STRUCTURAL & CORROSION WARRANTY THIRTY (30) YEARS

SUTPHEN CORPORATION (Sutphen) warrants the original user/purchaser that a new aerial platform or aerial ladder is, and will remain, free of corrosion perforation and structural defects, provided the aerial platform is used in a normal and reasonable manner. An aerial platform or aerial ladder is defined as the mechanically operated telescopic boom constructed of high-strength structural aluminum mounted on the fire truck. Excluded are all hardware, mechanical or electrical items, bucket, yoke and all normal wear items. The truck must be third party tested yearly. The Sutphen hourly maintenance schedule must be sent in to Sutphen for documentation that this work was performed per hourly schedule. This Structural Warranty shall supplement the Standard Vehicle Warranty.

Sutphen's obligation under this limited warranty is subject to the conditions precedent (1) that the claimed failure shall have first appeared during the warranty period; (2) that the original purchaser shall have notified Sutphen in writing of the claimed failure within thirty (30) days after the claimed failure shall have first appeared, and (3) that, unless Sutphen directs otherwise, the claimed failed item or items shall have been returned to Sutphen, or to Sutphen designee, promptly after the notification, with transportation charges prepaid. Sutphen reserves the right to thoroughly examine the vehicle or parts thereof, prior to conducting or approving any repair or replacement, to determine whether the claimed failure is covered by this warranty. Sutphen's obligation under this warranty is strictly limited to repair or replacement as the company may elect.

This limited warranty coverage shall be valid for a period of thirty (30) years from the delivery date to the original user/purchaser. Further, this warranty shall be void if the vehicle is involved in an accident, shows signs of abuse, or evidence of being operated in any improper manner.

This limited warranty covers only repair or replacement of any part of a Sutphen vehicle in which a defect in materials or workmanship appears within the limited warranty period. Examples of items not covered include, but are not limited to:

- A. ---Major components or trade accessories such as purchased chassis, engines, signaling devices, batteries, generators, tires, or transmissions that have a separate warranty by the original manufacturer, or to equipment used in firefighting.
- B. ---Unauthorized alteration or modification to the vehicle, including the body, chassis or components, after completion of the vehicle assembly by Sutphen and any problems that occur as a result of such alterations or modifications.
- C. ---Damage caused by collision, fire, theft, freezing, vandalism, riot, explosion, acts of God, war or objects striking the vehicle or any damage covered by owner insurance.
- D. ---Damage caused by misuse or improper operation of the vehicle such as driving over curbs, overloading, racing or off-road use.
- E. ---Damage caused by failure to follow the requirements of the maintenance schedule, failure to maintain proper fluid and lubricant levels and failure to follow operating instructions.
- F. ---Towing charges and storage expenses.
- G. ---Incidental expenses such as loss of vehicle use, inconvenience, loss of time, vehicle rental, lodging or travel costs, vacation pay, etc.
- H. ---Hydraulic pressures are not set to the correct PSI.
- I. ---Damage caused from exposure to road de-icing compounds or use in an acidic environment.
- J. ---Hydraulic failures caused by incorrect or contaminated oil.
- K. ---Hydraulic cylinder seal after one (1) year of service.

If proper maintenance has not been performed and documented on Sutphen Aerial Platform or Aerial Ladder Inspection forms and the forms sent to Sutphen at the time of check, all coverage is void.

This warranty terminates upon transfer of possession or ownership of the vehicle from the original purchaser.

THIS WARRANTY IS PROVIDED IN EXCLUSION OF ANY AND ALL OTHER REPRESENTATIONS, EITHER EXPRESSED OR IMPLIED, INCLUDING BUT NOT LIMITED TO THE WARRANTIES OF MERCHANTABILITY, FITNESS, AND SUITABILITY FOR BUYER'S INTENDED USE. NO PERSON IS AUTHORIZED TO MAKE ANY REPRESENTATIONS OR WARRANTIES ON BEHALF OF SUTPHEN CORPORATION OTHER THAN SET FORTH HEREIN. ANY MODIFICATION TO THIS WARRANTY MUST BE IN WRITING AND APPROVED BY THE PRESIDENT OF SUTPHEN CORPORATION. THE PROVISIONS OF THIS LIMITED WARRANTY SHALL CONSTITUTE THE SOLE AND EXCLUSIVE REMEDIES OF A SUTPHEN VEHICLE PURCHASER.

For more information contact:
Sutphen Corporation / Warranty Admin.
PO Box 1845 • Springfield, OH 45501
Phone (937) 969-8851 • Toll Free (866) 287-5549



AERIAL PLATFORM AND AERIAL LADDER MECHANICAL WARRANTY TWO (2) YEARS

SUTPHEN CORPORATION (Sutphen) warrants the original user/purchaser that the mechanical components of a new aerial platform or aerial ladder is, and will remain, free of corrosion perforation, structural defects, or failure provided that the components are used in a normal and reasonable manner. Mechanical components are defined as the hardware and mechanical items used on an aerial device. This Mechanical Warranty shall supplement the Standard Vehicle Warranty.

Sutphen's obligation under this limited warranty is subject to the conditions precedent (1) that the claimed failure shall have first appeared during the warranty period; (2) that the original purchaser shall have notified Sutphen in writing of the claimed failure within thirty (30) days after the claimed failure shall have first appeared, and (3) that, unless Sutphen directs otherwise, the claimed failed item or items shall have been returned to Sutphen, or to Sutphen designee, promptly after the notification, with transportation charges prepaid. Sutphen reserves the right to thoroughly examine the vehicle or parts thereof, prior to conducting or approving any repair or replacement, to determine whether the claimed failure is covered by this warranty. Sutphen's obligation under this warranty is strictly limited to repair or replacement as the company may elect.

This limited warranty coverage shall be valid for a period of two (2) years from the delivery date to the original user/purchaser. Further, this warranty shall be void if the vehicle is involved in an accident, shows signs of abuse, or evidence of being operated in an improper manner.

This limited warranty covers only repair or replacement of any part of a Sutphen vehicle in which a defect in materials or workmanship appears within the limited warranty period. Examples of items not covered include, but are not limited to:

- A. ---Major components or trade accessories that have a separate warranty by the original manufacturer, or equipment used in firefighting.
- B. ---Unauthorized alteration or modification to the vehicle, including the aerial, body, chassis or components, after completion of the vehicle assembly by Sutphen and any problems that occur as a result of such alterations or modifications.
- C. ---Damage caused by collision, fire, theft, freezing, vandalism, riot, explosion, acts of God, war or objects striking the vehicle or any damage covered by owner insurance.
- D. ---Damage caused by misuse or improper operation of the vehicle such as driving over curbs, overloading, racing or off-road use.
- E. ---Damage caused by failure to follow the requirements of the maintenance schedule, failure to maintain proper fluid and lubricant levels and failure to follow operating instructions.
- F. ---Normal maintenance items such as lubrication, cables, shives, pivot bearings, pivot shafts, etc.
- G. ---Towing charges and storage expenses.
- H. ---Incidental expenses such as loss of vehicle use, inconvenience, loss of time, vehicle rental, lodging or travel costs, vacation pay, etc.
- I. ---Damage to discharge and compound gauges from freezing.
- J. ---Leaking seals on discharge and suction valves.
- K. ---Damage caused from exposure to road de-icing compounds or use in an acidic environment.
- L. ---Hydraulic failures caused by incorrect or contaminated oil.
- M. ---Hydraulic pressure caused by incorrect PSI settings.
- N. ---Hydraulic cylinder seal after one (1) year service.
- O. ---Electric reels, air reels, electric controls and components.

If proper maintenance has not been performed and documented on Sutphen Aerial Inspection forms and sent to Sutphen at time of check, all coverage is void.

This warranty terminates upon transfer of possession or ownership of the vehicle from the original purchaser.

THIS WARRANTY IS PROVIDED IN EXCLUSION OF ANY AND ALL OTHER REPRESENTATIONS, EITHER EXPRESSED OR IMPLIED, INCLUDING BUT NOT LIMITED TO THE WARRANTIES OF MERCHANTABILITY, FITNESS, AND SUITABILITY FOR BUYER'S INTENDED USE. NO PERSON IS AUTHORIZED TO MAKE ANY REPRESENTATIONS OR WARRANTIES ON BEHALF OF SUTPHEN CORPORATION OTHER THAN SET FORTH HEREIN. ANY MODIFICATION TO THIS WARRANTY MUST BE IN WRITING AND APPROVED BY THE PRESIDENT OF SUTPHEN CORPORATION. THE PROVISIONS OF THIS LIMITED WARRANTY SHALL CONSTITUTE THE SOLE AND EXCLUSIVE REMEDIES OF A SUTPHEN VEHICLE PURCHASER.

For more information contact:
Sutphen Corporation / Warranty Admin.
PO Box 1845 • Springfield, OH 45501
Phone (937) 969-8851 • Toll Free (866) 287-5549

