



**SUTPHEN CORPORATION
MODEL SPH 100
AERIAL PLATFORM
OPERATOR AND MAINTENANCE MANUAL**



SUTPHEN

IMPORTANT

READ AND UNDERSTAND THIS MANUAL BEFORE OPERATING

FAILURE TO USE, UNDERSTAND, AND FOLLOW PROPER USAGE INSTRUCTIONS AS MADE AVAILABLE BY SUTPHEN CORPORATION/OPERATOR'S MANUAL, VARIOUS VENDOR SUPPLIED LITERATURE, GUIDELINES OF N.F.P.A., I.S.F.S.I., O.S.H.A., ETC., COULD CAUSE SERIOUS INJURY AND/OR DEATH.

**SUTPHEN
Since 1890**

Rev. 23 - Dec 2022



Chapter 1 Operator Manual

	<u>Page</u>
1.1 Introduction.....	1-4
1.2 Aerial Platform Operation.....	1-5
<i>Operation Safety Points</i>	1-5
1.3 Safety Tags.....	1-9
<i>Warning/Danger/Caution Labels List</i>	1-27
<i>Safety Tags Location</i>	1-29
<i>SPH 100 Warning Tags</i>	1-30
<i>SPH 100 Warning Tags List</i>	1-40
1.4 Cab Setup Procedures	1-42
<i>Locating the Vehicle</i>	1-42
<i>Activating the Hydraulic System</i>	1-42
1.5 Cab Setup for Fire Pump Operation.....	1-44
1.6 Aerial Setup Procedures.....	1-49
1.7 Stabilizing System.....	1-49
<i>Ground Jack Controls</i>	1-49
1.8 Safety Pins.....	1-55
1.9 Transfer Fluid for Aerial Operation	1-58
1.10 Stabilizer Interlock System	1-59
<i>Stabilizer Interlock Override Procedure</i>	1-59
1.11 Rotation Interlock System.....	1-60
1.12 Smart Boom Warning System.....	1-61



1.13	Aerial Operational Controls	1-63
	<i>Raise/Lower</i>	1-64
	<i>Extend/Retract</i>	1-65
	<i>Rotation</i>	1-65
	<i>Fairfield Drive Rotation Brake</i>	1-66
	General Information	1-66
	Location of The Rotation Brake	1-67
	Releasing the Brake Valve	1-67
	<i>High-Speed Control</i>	1-69
	<i>Low Range Switch</i>	1-70
	<i>Auxiliary Hydraulic Power Switch</i>	1-70
1.14	Water Delivery System	1-71
	<i>Telescopic Waterway</i>	1-71
	<i>Platform Water System</i>	1-72
1.15	Cold Weather Operations	1-73
	<i>Draining the Waterway</i>	1-73
1.16	Draining the Fire Pump	1-73
1.17	Platform Mounting and Leveling System	1-74
	<i>Leveling System Override</i>	1-74
1.18	Optional Breathing Air System.....	1-75
1.19	Climbing Aerial or Using as an Escapeway.....	1-76
1.20	Rappelling	1-76
1.21	Loading Hose	1-76
1.22	Aerial Take-Down Procedures	1-77
	<i>Stowing the Aerial Device</i>	1-77



1.23	Operation and Functional Description of Pinless Aerial Jacks.....	1-80
	<i>Components</i>	1-80
	<i>Setup Procedure</i>	1-80
	<i>Tear Down Procedure</i>	1-86
	<i>Short Jack Procedure</i>	1-87
	<i>Truck Power Loss While Set On Jacks</i>	1-89
	<i>Jack Down Pressure Sensor</i>	1-90
	<i>Functional Description</i>	1-92

Chapter 2

Maintenance Manual

	<u>Page</u>	
2.1	Aerial Maintenance	2-3
	<i>Outrigger Beams</i>	2-3
	<i>Main Lift Cylinders</i>	2-3
	<i>Pivot Shaft Bearings</i>	2-3
	<i>Turntable Bearing</i>	2-3
	<i>Fairfield Drive</i>	2-4
	<i>Aerial Extension/Retraction Cylinders</i>	2-5
	<i>Sheaves and Cables</i>	2-5
	<i>Cable Adjustment</i>	2-6
	Before Extending Aerial	2-6
	<i>Slide Block</i>	2-19
	Lubrication	2-19
	Description	2-19
	Daily Preventative Maintenance (PM)	2-20
	Before Beginning	2-20



	Standard Operating Procedure	2-21
	Periodic Preventative Maintenance (PM)	2-23
	<i>Cable Track</i>	2-24
	Maintenance	2-24
	<i>Waterway and Seals</i>	2-26
	<i>Torque-Hub® Planetary Final Drive ATC8300</i>	
	<i>Counterbalance Valve</i>	2-27
	Assembly	2-27
	<i>Hydraulic Oil Tank</i>	2-29
	<i>Hydraulic Oil Tank Fill Procedure</i>	2-30
	<i>SPH 100 Fitted with KFS 4447 Reservoir Assembly</i>	2-31
	<i>Fuel Tank</i>	2-33
2.2	Maintenance of Structure	2-34
	<i>Aluminum Tower Structure</i>	2-34
	<i>Attachment of Support Structure to Truck Frame</i>	2-34
	<i>Chassis Maintenance</i>	2-34
2.3	Aerial Tower Lubrication Requirements	2-35
2.4	Torque Values for Various Fasteners.....	2-37
	Daily/Weekly Walk-Around Check for Mobile Fire Apparatus	

Chapter 3

Warranty

Aerial Platform or Aerial Ladder Structural and Corrosion Warranty

 Thirty (30) Years..... 3-3

Aerial Platform and Aerial Ladder Mechanical Warranty

 Two (2) Years



Chapter 1 Operator Manual

	<u>Page</u>
1.1 Introduction.....	1-4
1.2 Aerial Platform Operation.....	1-5
<i>Operation Safety Points</i>	1-5
1.3 Safety Tags.....	1-9
<i>Warning/Danger/Caution Labels List</i>	1-27
<i>Safety Tags Location</i>	1-29
<i>SPH 100 Warning Tags</i>	1-30
<i>SPH 100 Warning Tags List</i>	1-40
1.4 Cab Setup Procedures	1-42
<i>Locating the Vehicle</i>	1-42
<i>Activating the Hydraulic System</i>	1-42
1.5 Cab Setup for Fire Pump Operation.....	1-44
1.6 Aerial Setup Procedures.....	1-49
1.7 Stabilizing System.....	1-49
<i>Ground Jack Controls</i>	1-49
1.8 Safety Pins.....	1-55
1.9 Transfer Fluid for Aerial Operation	1-58
1.10 Stabilizer Interlock System	1-59
<i>Stabilizer Interlock Override Procedure</i>	1-59
1.11 Rotation Interlock System.....	1-60
1.12 Smart Boom Warning System.....	1-61

▽ **Operator Manual**

1.13	Aerial Operational Controls	1-63
	<i>Raise/Lower</i>	1-64
	<i>Extend/Retract</i>	1-65
	<i>Rotation</i>	1-65
	<i>Fairfield Drive Rotation Brake</i>	1-66
	General Information	1-66
	Location of The Rotation Brake	1-67
	Releasing the Brake Valve	1-67
	<i>High-Speed Control</i>	1-69
	<i>Low Range Switch</i>	1-70
	<i>Auxiliary Hydraulic Power Switch</i>	1-70
1.14	Water Delivery System	1-71
	<i>Telescopic Waterway</i>	1-71
	<i>Platform Water System</i>	1-72
1.15	Cold Weather Operations	1-73
	<i>Draining the Waterway</i>	1-73
1.16	Draining the Fire Pump	1-73
1.17	Platform Mounting and Leveling System	1-74
	<i>Leveling System Override</i>	1-74
1.18	Optional Breathing Air System.....	1-75
1.19	Climbing Aerial or Using as an Escapeway.....	1-76
1.20	Rappelling	1-76
1.21	Loading Hose	1-76
1.22	Aerial Take-Down Procedures	1-77
	<i>Stowing the Aerial Device</i>	1-77



1.23	Operation and Functional Description of Pinless Aerial Jacks.....	1-80
	<i>Components</i>	1-80
	<i>Setup Procedure</i>	1-80
	<i>Tear Down Procedure</i>	1-86
	<i>Short Jack Procedure</i>	1-87
	<i>Truck Power Loss While Set On Jacks</i>	1-89
	<i>Jack Down Pressure Sensor</i>	1-90
	<i>Functional Description</i>	1-92

1.1 Introduction

This manual has been prepared with the assistance of service and engineering specialists to acquaint you with the operation and maintenance of your new apparatus. You are urged to read this manual carefully. Following the instructions and recommendations in this manual will help ensure the safe and enjoyable operation of your apparatus.

After you have read this manual, it should be stored in the apparatus or another location which enables quick and easy reference for all firefighters.

Throughout this manual, the words **WARNING, DANGER, and CAUTION** appear. These serve as reminders to follow all instructions carefully. Failure to follow instructions can cause personal injury or damage to your apparatus.

This manual has been written to help in the setup and use of the tower during emergencies and training.

There may be circumstances that arise throughout the life of this apparatus which do not appear in this manual. At all times, common sense and safety should be your first consideration.

Sutphen knows your apparatus best and has the parts and factory-trained technicians available to keep your apparatus in an ever-ready state. Sutphen Corporation works towards giving you complete satisfaction. Please do not hesitate to contact Sutphen Corporation at 1-866-287-5549.



1.2 Aerial Platform Operation

Operation Safety Points

When the truck is delivered, a factory-trained representative will demonstrate the proper use of the apparatus. The department must continue this to achieve a proficient level of training.

The aerial tower is only as good or as safe as the operator is competent. Continued training and familiarization is essential.

An operator **MUST** be at the lower control station anytime the aerial is being operated.

Personnel should not climb the aerial tower until the lower controls operator indicates that it is safe to do so. The upper power switches must be turned off in the platform and at the turntable pedestal before climbing the ladder.

Rating of the aerial: Model SPH 100 - 1,000 lbs.

Rating in the bucket: Model SPH 100 - 500 lbs. while flowing water
or with charged waterway

Do not operate turntable controls while personnel are climbing the tower.

Personnel should use an approved life belt when operating on the aerial tower.

At night, the entire aerial tower should be well lighted.

Do not forcefully extend the end of the tower against a structure.

Never use the aerial as a battering ram.

Never use the aerial for pulling down walls or structural members.

Never willingly or intentionally abuse an aerial by careless handling, overloading, or use for which it was not designed.

Operate the aerial with deliberate motions and smooth application of power.

Training and practice with the apparatus on a regular basis is a must for safe operation.

Auxiliary ground pads should always be used under the outrigger feet when operating the aerial tower.

Do not use auxiliary ground pads under the rear jacks unless they are metal, as these jacks are used as a grounding point.

Safety lock pins on stabilizers shall always be in place.

Never move the vehicle with stabilizers in contact with ground.

Most problems encountered with operation of the tower are caused by inadequate maintenance. To keep the tower fully operational, routine lubrication policies must be followed.

The aerial should be inspected and tested annually in accordance with NFPA 1914, Testing Fire Department Aerial Apparatus.

Frequently inspect the chassis and running gear and maintain in good mechanical condition following recommended schedules in this manual. The aerial tower is of no use unless it can be transported to where it is needed. Careful, safe driving rules should be observed for the same reason.

Carefully and frequently check and inspect the entire aerial for loose bolts or rivets, unlubricated bearing surfaces, bent, warped, or twisted parts, hydraulic leaks, defective electric control equipment, etc. Follow the recommended maintenance schedules in this manual.

All members should frequently practice the different phases of aerial operations.

Never set up the aerial on marshy ground, freshly filled ground, or other soft surface.



Never apply opposing alternating control when operating the aerial, either in a side-to-side motion, a front-to-rear motion, or an up-and-down motion. This may set up an accelerated oscillation, which could put undue strain on the structure and cause immediate or eventual failure of the aerial tower and injury to the occupants and bystanders.

Do not overload the aerial. Learn and observe the load limit indicated at the operator's positions.

When raising an aerial platform to rescue people at roofs or windows, avoid raising the platform in line with the people. Either raise off to one side and rotate to the people or raise perpendicular to them and rotate toward them. This is because panic-stricken persons seeing the platform within reach below them could try jumping into it.

Although the aerial is designed for one person setup, it is a good safety practice to designate a person to observe the right-side stabilizer when the stabilizers are being set up. This person can place the stabilizer pad and observe that it is placed evenly and correctly and that the stabilizer is set properly.

Many accidents with aerial devices nationwide occur during nonemergency operation. For this reason, the aerial should not be operated by one person alone. Operators checking out or operating the tower alone in front of the station can forget something or be overconfident and get into trouble. “Two heads are better than one”.

Never allow an untrained person or a person who is not thoroughly familiar with this aerial to operate it unless constantly supervised.

That person must:

1. Be capable of spotting the vehicle properly.
2. Be able to stabilize the vehicle properly.
3. Know the location of every control.
4. Know what each control does and how it works.
5. Be able to operate all controls smoothly and safely.
6. Know the location of safety devices, how they work, and how to operate them.
7. Be familiar with the loads that the aerial can safely accommodate under various operating conditions.
8. Be aware of how to operate the aerial under unusual circumstances.

When you consider the cost of an aerial platform, the lives that could be at stake, and the damage that could occur to the equipment, the importance of practice and training becomes very clear.



WARNING

Before operating this apparatus you must:

1. *Be thoroughly familiar with this instruction manual.*
2. *Be thoroughly trained in the operation of this apparatus.*
3. *Operate this apparatus in strict accordance with the manufacturer's recommendations.*
4. *Operate this apparatus in accordance with departmental rules and regulations.*
5. *Always set up the apparatus on concrete, blacktop, or gravel. Surface must be firm and solid.*

Failure to do so could result in injury or death to persons operating or working on or around this apparatus.

Failure to do so could also result in damage to this apparatus.



1.3 Safety Tags

On the following pages are the various safety tags found on the apparatus. All of the tags found here may not be used on your particular vehicle, as some are related to optional equipment. Included in this manual is a drawing showing the locations of these various tags on the apparatus. Should any of these tags become damaged or lost throughout the life of your vehicle, please contact Sutphen Corporation at 1-866-287-5549 for replacements.

Operator Manual

Safety Tags

TAG 16



TAG 15



TAG 17



TAG 10



Sutphen-5



TAG 22



7.25 x 3.50

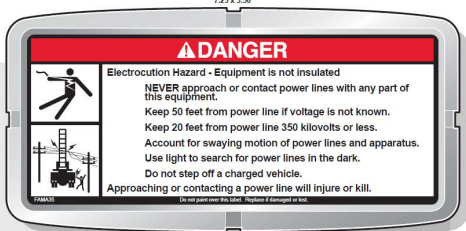

6.63 x 2.75

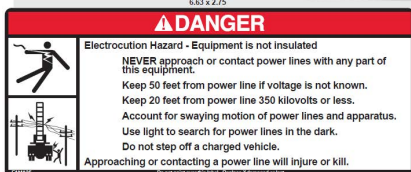

FAMA 35

3.50 x 3.50



TAG 21



Sutphen-6

Operator Manual

TAG 38-1



TAG 56



TAG 57



TAG 36



TAG 38



Sutphen-7



TAG 55

SAFETY INSTRUCTIONS

Jump Starting Precautions:

1. Jump starting with voltages greater than 16 volts DC or reversing the polarity will damage the engine computer.
2. Before attempting to jump-start the engine, make sure jumper cables are connected properly (positive to positive, negative to negative) and in the proper sequence (connect positive to positive first). Failure to do so can result in alternator and/or equipment damage.
3. Reversing battery polarity can also result in personal injury caused by a sudden discharge of electrolyte from the battery vents or by the sudden rupture of the battery case caused by an explosion of internal hydrogen gas.

Battery Charging Precautions

1. When using battery charger to charge batteries, set on 12 VOLT LOW CHARGE. Do not exceed a maximum of 16 volts DC.
2. Electrical damage or explosion can occur when charging batteries or boosting batteries.

Welding Precautions:

1. Serious damage to the ECM(s) and DDEC components may result from welding if all ECM connectors are not disconnected.
2. Serious damage to the multiplexed platform controls may occur if the power supply to them is not disconnected.

Sutphen

Operator Manual

TAG 66



TAG 281

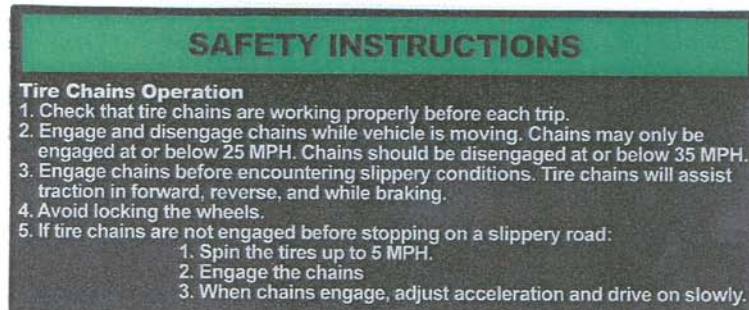

TAG 59



TAG 58



Sutphen-9



SAFETY INSTRUCTIONS

Before raising cab:

1. Read operator manual.
2. Provide sufficient cab clearance.
3. Secure or remove any loose items.
4. Make sure nothing is on the front bumper.
5. Make sure cab doors are shut and latched.
6. Make sure cab tilts fully and the safety bar engages.

Before lowering cab:

1. Make sure all service items are removed from engine area.
2. Raise cab to maximum height to release safety latch.
3. Make sure all personnel are clear of cab area.
4. Pull safety latch handle and hold out to lower cab.

TAG 323

TAG 328

⚠ DANGER



Fall Hazard

Do not open valves completely. Use only in an emergency.

TAG 322

⚠ WARNING



Crushing injuries may occur.

Stand clear when lowering cab.

TAG 327

SAFETY INSTRUCTIONS

Leveling System Override:

1. For emergency use only
2. Open only if automatic leveling system fails.
3. Open both valves one turn.
4. Read operator's manual before operating this equipment.

TAG 310

Computer Code Switch

TAG 324

Cab Tilt

Up



Down

TAG 325

Cab Tilt Safety Latch

Pull to Release

Sutphen-16

TAG 326



Sutphen-11



TAG 385



TAG 365

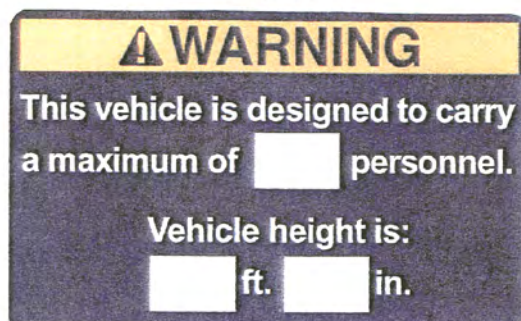

TAG 355



Sutphen-12

Operator Manual

▲ WARNING TAG 382

Serious injury
or death may
occur if inlets
are supplied by
a pressurized
source when
valve is closed.

TAG 381

**ABS
Code Switch**

TAG 370

**All equipment in the platform
must be mounted in a holder.
The total weight of equipment
should not exceed 80 lbs.**

7.25 x 3.50

▲ WARNING

Only trained personnel should operate this equipment. Personnel connecting supply or discharge hoses must be trained to recognize and respond to water hydraulics hazards and component limitations.

Do not operate or service until you have read, understood, and been trained and qualified on the procedures found in the latest editions of NFPA standards including 1511, 1451, 1500; IFSTA Handbooks; and the operation and service manuals supplied with this equipment.

Replacement manuals are available from the manufacturer of this apparatus.

Operating or servicing without knowledge or training may lead to injury or death for you or others.

6.63 x 2.75

▲ WARNING

Only trained personnel should operate this equipment. Personnel connecting supply or discharge hoses must be trained to recognize and respond to water hydraulics hazards and component limitations.

Do not operate or service until you have read, understood, and been trained and qualified on the procedures found in the latest editions of NFPA standards including 1511, 1451, 1500; IFSTA Handbooks; and the operation and service manuals supplied with this equipment.

Replacement manuals are available from the manufacturer of this apparatus.

Operating or servicing without knowledge or training may lead to injury or death for you or others.

FAMA 25

TAG 375

▲ CAUTION

Properly set rear
jacks before raising
the boom to load
hose, fill water
tank, etc.

Failure to do so
may result in body
or chassis damage.

TAG 368

To Engage PTO:

1. Bring engine to idle.
2. Move PTO switch to ON position.
3. Confirm that PTO dash light is on.
4. Resume operations.

Sutphen-13



TAG 407



TAG 417

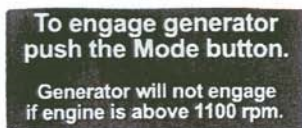

TAG 416

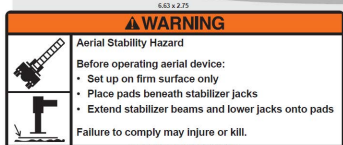
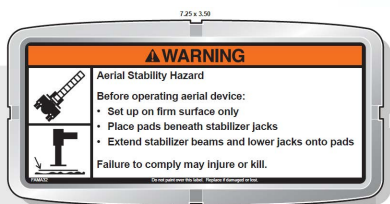

TAG 410



TAG 395



Sutphen-14

Operator Manual

TAG 405

⚠ DANGER

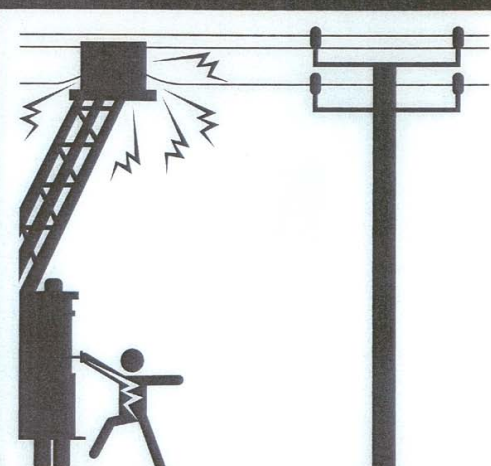

Electrocution Hazard

Death or serious injury may result from contact with this vehicle if it should be electrically charged.

Maintain 17 foot minimum clearance from all power sources during aerial operations.



Pump operator must use pull-out safety platform during aerial operations.

Always designate a spotter at pedestal to help avoid power lines during aerial operations.

Avoid simultaneous contact with truck and ground during aerial operations.

Stuphen-15

⚠ DANGER

Electrocution Hazard - Equipment is not insulated

NEVER approach or contact power lines with any part of this equipment.

Keep 50 feet from power line if voltage is not known.

Keep 20 feet from power line 350 kilovolts or less.

Account for swaying motion of power lines and apparatus.

Use light to search for power lines in the dark.

Do not step off a charged vehicle.

Approaching or contacting a power line will injure or kill.

Do not paint over this label. Replace if damaged or lost.

⚠ WARNING



Fall Restraint Required

All personnel on aerial ladder or platform must wear safety harness with restraint belt properly attached to the device.

Fall will injure or kill.

Do not paint over this label. Replace if damaged or lost.

⚠ WARNING



Fall Restraint Required

All personnel on aerial ladder or platform must wear safety harness with restraint belt properly attached to the device.

Fall will injure or kill.

Do not paint over this label. Replace if damaged or lost.



TAG 427

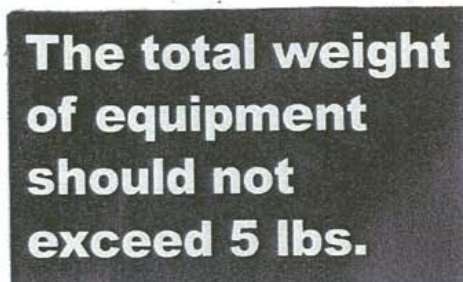

TAG 440



TAG 438

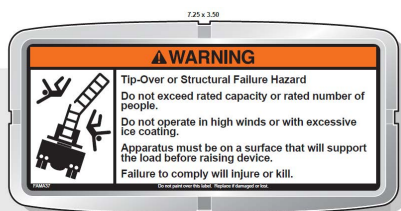

FAMA 37

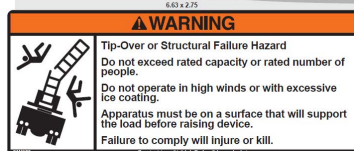

643 x 275



TAG 436

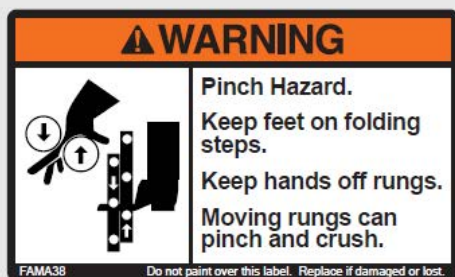

FAMA38

Do not paint over this label. Replace if damaged or lost.



TAG 426

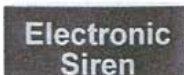

TAG 425



TAG 424



TAG 435

Sutphen-16

Operator Manual

TAG 406 UP DOWN
 Front Axle Lock
 RET EXT
 Left Front Stabilizer
 RET EXT
 Left Rear Stabilizer
 RET EXT
 Right Front Stabilizer
 RET EXT
 Right Rear Stabilizer
 UP DOWN
 Right Stabilizer
 UP DOWN
 Left Stabilizer
 UP DOWN
 Rear Stabilizer

TAG 414

INSTALL SAFETY PINS

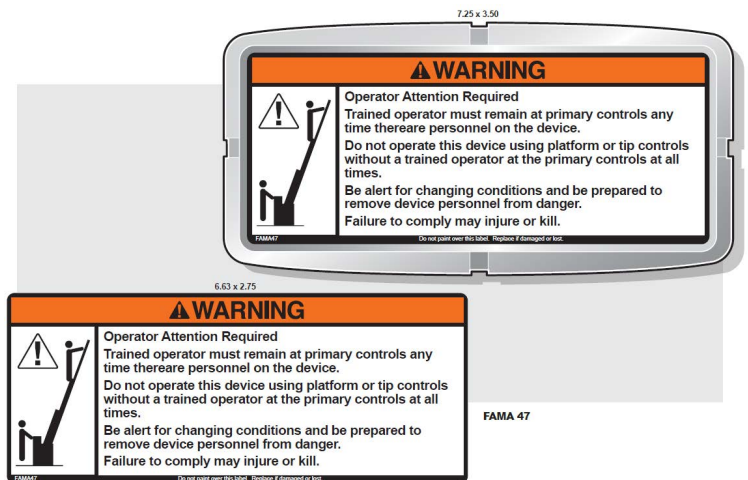



TAG 431



CHASSIS DATA

Sutphen Corporation
7000 Columbus-Marysville Road
Amlin, OH 43022
(800) 848-5860

CHASSIS FILTERS

CHASSIS ENGINE OIL FILTER PART NO.	
TRANSMISSION OIL FILTER PART NO.	
CHASSIS AIR CLEANER FILTER PART NO.	
CHASSIS FUEL FILTER PRIMARY PART NO.	
CHASSIS FUEL FILTER SECONDARY PART NO.	
CHASSIS ENGINE WATER FILTER PART NO.	
AIR DRYER ASSEMBLY FILTER PART NO.	
AERIAL HYDRAULIC FILTER CARTRIDGE PART NO.	

CHASSIS SPECIFICATIONS

MODEL		TRUCK NO.	
FRONT TIRES		REAR TIRES	
ENGINE			
SERIAL NO.		NO. CYLINDERS	
BORE		STROKE	
H.P. SAFE		DISPLACEMENT	
PAINT COLOR			

TAG 430



Sutphen Corporation
7000 Columbus-Marysville Road
Amlin, OH 43022
(800) 848-5860

PUMP DATA

		PUMP MAKE	HALE	
		GPM	PRESSURE	ENGINE RPM
		XXXXXX	150 PSI	XXXXXX
		XXXXXX	200 PSI	XXXXXX
		XXXXXX	250 PSI	XXXXXX
CAPACITY		1500	GPM	
MODEL NO.	QMAX 150-23S			
SERIAL NO.	QMAX 150-23S			
PRODUCTION NO.	QMAX 150-23S			
		GOVERNOR SPEED	2100	RPM
		GEAR RATIO	2.28	TO 1

Sutphen-18

Operator Manual

TAG 434



WARNING
 Keep legs and feet inside kick guard during aerial operations. Failure to do so may result in serious injury or death.

POWER SOURCE SPECIFICATIONS

OPERATIONAL CATEGORY	CONTINUOUS DUTY RATING
RATED VOLTAGE(S) AND TYPE (AC OR DC)	XXXXXX
PHASE	XXXXXX
RATED FREQUENCY	XXXXXX
RATED AMPERAGE	XXXXXX
CONTINUOUS RATED WATTS	XXXXXX
POWER SOURCE ENGINE SPEED	XXXXXX

TAG 433

TAG 432

Sutphen Corporation
 7000 Columbus-Marysville Road
 Amlin, OH 43022
 (800) 848-5860

FLUID DATA

	QTY.	TYPE		QTY.	TYPE
CHASSIS ENGINE OIL			CAB TILT MECH. FLUID		
CHASSIS ENGINE COOLANT			TRANSFER CASE FLUID / AUTO LUBE		
CHASSIS TRANSMISSION FLUID			EQUIPMENT RACK FLUID		
PUMP TRANSMISSION FLUID			GENERATOR SYSTEM LUBRICANT		
PUMP PRIMER FLUID			AERIAL-TOWER HYDRAULIC FLUID		
DRIVE AXLE LUBRICATION FLUID			LEVELING SYSTEM FLUID		
AIR-CONDITIONING REFRIGERANT FLUID			FUEL TANK DIESEL NO. 2		
AIR-COND. LUBRICAT. OIL SYS. LUBRICANT			FRONT TIRE COLD PSI		
POWER STEERING FLUID			REAR TIRE COLD PSI		
MONTH-YEAR BUILT			DATE SHIPPED		
VEHICLE IDENTIFICATION NO.				HS-	

Sutphen-19

TAG 441

UP Front Axle Lock DOWN	RET Right Front Stabilizer EXT	RET Left Front Stabilizer EXT	UP Right Stabilizer DOWN	UP Left Stabilizer DOWN	UP Rear Stabilizer DOWN
----------------------------------	---	--	-----------------------------------	----------------------------------	----------------------------------

TAG 442

▲ WARNING Maximum lifting eye capacity of 800 lbs.

▲ WARNING Static load only. No rappelling from platform.

▲ WARNING Any weight suspended from lifting eye must be subtracted from available platform payload.

TAG 446

SAFETY INSTRUCTIONS

1. Lifting eye capacity - 800 lbs.
2. Any weight suspended from eye must be subtracted from platform capacity.



TAG 447

SAFETY INSTRUCTIONS

1. Stokes arm capacity - 250 lbs.
2. Max. of 500 lbs. in platform when using Stokes Arms.

TAG 448

WHEN DIFFERENTIAL LOCK IS ENGAGED, THE MAXIMUM SPEED IS 25 MPH

TAG 449

⚠ CAUTION
When filling water tank, do not exceed 100 psi. Failure to do so could cause the tank to rupture.

TAG 454

⚠ WARNING
Do Not Exceed Wattage Rating of Generator. Generator may be Permanently Damaged and Void Warranty.

TAG 452

GEN. PTO

TAG 455

Ladder Belt Tie-Off Point
⚠ WARNING
Not For Rescue or Rappelling
250lb. Max.

Sutphen-21



Warning/Danger/Caution Labels List

TAG 10	ALIGNMENT LIGHT
TAG 15	DO NOT MODIFY
TAG 16	DO NOT GET OIL IN EYES
TAG 17	STAND ON STEP - ELECTROCUTION
TAG 18	PINCH POINT
TAG 19	CRUSHING INJURY
TAG 20	ELECTROCUTION HAZARD
TAG 21	LIFTING EYE
TAG 22	DO NOT CLIMB BOOM
TAG 23	AERIAL DATA PLACARD
TAG 36	FIRE MAY OCCUR
TAG 38	BREATHING OF FUMES
TAG 38-1 HORZ.	BREATHING OF FUMES
TAG 55	JUMP STARTING PRECAUTIONS
TAG 56	EXPLOSION MAY OCCUR - BATTERIES
TAG 57	OCCUPANTS MUST BE SEATED
TAG 58	DO NOT USE AUXILIARY BRAKING
TAG 59	STAY CLEAR OF FAN
TAG 66	STAND CLEAR OF OUTRIGGER
TAG 281	TIRE CHAIN OPERATION
TAG 310	COMPUTER CODE SWITCH
TAG 322	STAND CLEAR - LOWERING CAB
TAG 323	BEFORE RAISING CAB
TAG 324	CAB TILT UP & DOWN
TAG 325	CAB TILT SAFETY LATCH
TAG 326	DO NOT RAPPEL FROM AERIAL
TAG 327	LEVELING SYSTEM OVERRIDE
TAG 328	FALL HAZARD
TAG 353	SUTPHEN - TEAMSTER LOGO
TAG 365	CARRY MAX. PERSONNEL
TAG 368	TO ENGAGE PTO
TAG 370	EQUIPMENT MOUNTED
TAG 375	SET REAR JACKS
TAG 381	ABS CODE SWITCH
TAG 385	POSITIVE/NEGATIVE
TAG 395	FLOW OR RECIRCULATE

Warning/Danger/Caution Labels List - Continued

TAG 405	ELECTROCUTION HAZARD
TAG 407	PEDESTAL AREA
TAG 408	LOCK - DOWN
TAG 409	EXITING BUCKET
TAG 410	EXITING CAB
TAG 416	SAFETY CHAIN FASTENED
TAG 417	ENGAGE GENERATOR
TAG 424	AIR HORN
TAG 425	ELECTRIC SIREN
TAG 426	MECHANICAL SIREN
TAG 427	DO NOT WALK ON SURFACE
TAG 430	PUMP DATA PLACARD
TAG 431	CHASSIS DATA PLACARD
TAG 432	FLUID DATA PLACARD
TAG 433	POWER SOURCE SPECS.
TAG 434	KEEP FEET INSIDE KICK GUARD
TAG 435	KUSSMAL AUTO-PUMP DRAIN
TAG 436	FRONT SUCTION - RAISING CAB
TAG 438	WATERWAY VALVE OVERRIDE
TAG 439	INSTALL SAFETY PIN (VERTICAL)
TAG 440	EQUIPMENT LIMITS - 5 LB. (BUCKET)
TAG 441	MANUAL OVERRIDE OUTRIGGER CONTROLS (SPH)
TAG 442	BUCKET STATIC LOAD
TAG 443	PUMP DATA PLACARD (METRIC)
TAG 444	TIRE PRESSURE FR. 120 R. 95
TAG 445	TIRE PRESSURE FR. 120 R. 110
TAG 446	LIFTING EYE CAPACITY 800 LB.
TAG 447	STOKES ARM CAPACITY 250 LB.
TAG 448	DIFFERENTIAL LOCK ENGAGEMENT
TAG 449	WATER TANK REFILL
TAG 450	PRESS. GOV. RPM MODE
TAG 451	HYDR. COMPT. JACK CONTROL 95/100
TAG 452	GENERATOR PTO
TAG 453	TIRE PRESSURE (AERIAL)
TAG 454	GENERATOR
TAG 455	LADDER BELT TIE-OFF POINT

Operator Manual

SPH-100 WARNING TAGS

See Sheets 2-5 for Driver Side warning tags/locations
 See Sheets 6-7 for Officer Side warning tags/locations
 See Sheet 8 for Rear warning tags/locations
 See Sheet 9-10 for Bucket warning tags/locations

DIMENSIONS ARE IN INCHES DIMENSIONAL TOLERANCES (UNLESS OTHERWISE NOTED)		 SUTPHEN CORPORATION FIRE APPARATUS SINCE 1890 8450 EBERMAN ROAD DUBLIN, OH 43016 800-848-5860
.XX = ±.06	ANGLE = ±1°	
.XXX = ±.031	FRACT = ±1/16	
A.O INITIAL RELEASE	MW	SEE BILL OF MATERIAL
MATERIAL THICKNESS-		DESCRIPTION
DESCRIPTION	ECN#	DATE
BY	QTY	WEIGHT
	39913.2	LBS
A.E Item Number		DOCUMENT NUMBER
		SPH_Labels
		SHEET
		1 OF 10

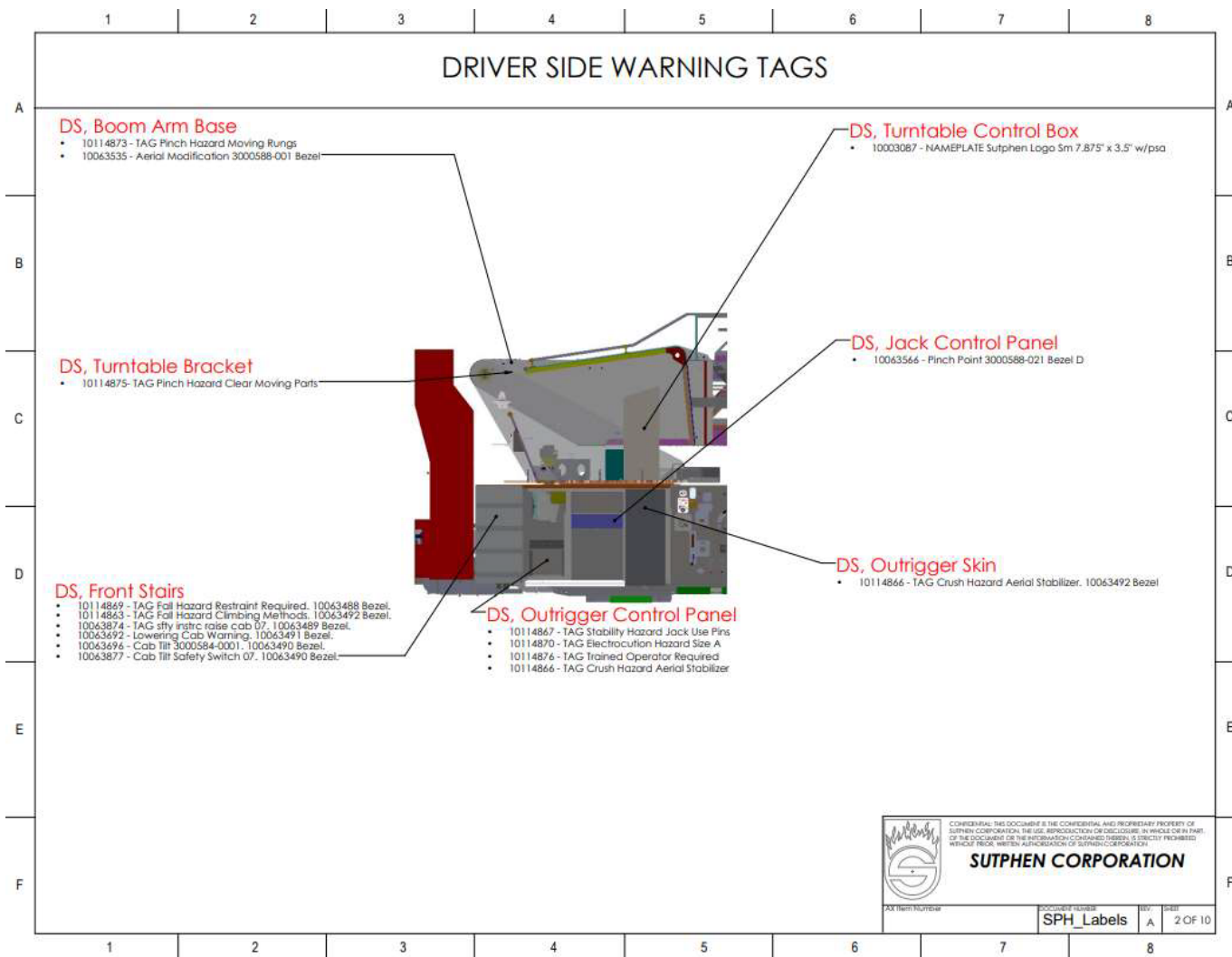

Operator Manual

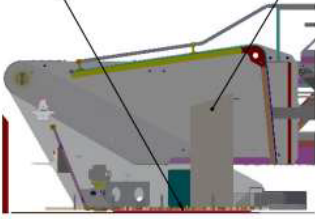
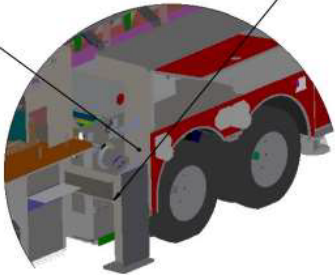
	1	2	3	4	5	6	7	8								
	DRIVER SIDE WARNING TAGS CONT'D															
A	<p>DS, Turntable Base</p> <ul style="list-style-type: none"> • 10063804 - TAG Turntable Area Safety, 10063490 Bezel • 10114875 - TAG Pinch Hazard Keep Clear Moving Parts, 10063490 Bezel 			<p>DS, Turntable Controls (under lid)</p> <ul style="list-style-type: none"> • 10114870 - TAG Electrocutation Hazard Size A, • 10114872 - TAG Failure Do Not Exceed Capacity, • 10114867 - TAG Stability Hazard Jack Use Pins, • 10114865 - TAG Safety Trained Personnel Only, • 10151251 - LABEL, VERTICAL ON/OFF SIZE C WITH ARROW, 10012479 Bezel • 10114874 - TAG Inspection Required 												
B																
C																
D	<p>DS, Front of Mid-Body</p> <ul style="list-style-type: none"> • 10114862 - TAG Crash Hazard Loose Hose • 10114870 - TAG Electrocutation Hazard • 10114865 - TAG Safety Trained Personnel Only • 10114863 - TAG Fall Hazard Climbing Methods 			<p>DS, Outrigger Bracket</p> <ul style="list-style-type: none"> • 10063815 - INSTALL SAFETY PIN L • 10017596 - TAPE mov 2" w 6" red/6" wht DO conspicuity tape 												
E																
F							<p>CONFIDENTIAL: THIS DOCUMENT IS THE CONFIDENTIAL AND PROPRIETARY PROPERTY OF SUTPHEN CORPORATION. THE USE, REPRODUCTION OR DISCLOSURE, IN WHOLE OR IN PART, OF THE DOCUMENT OR THE INFORMATION CONTAINED THEREIN, IS STRICTLY PROHIBITED WITHOUT PRIOR WRITTEN AUTHORIZATION OF SUTPHEN CORPORATION.</p> <p style="text-align: center;">SUTPHEN CORPORATION</p> <table border="1"> <tr> <td>AX With Number</td> <td>DOCUMENT REVISION</td> <td>REV</td> <td>DRAW</td> </tr> <tr> <td></td> <td>SPH_Labels</td> <td>A</td> <td>3 OF 10</td> </tr> </table>		AX With Number	DOCUMENT REVISION	REV	DRAW		SPH_Labels	A	3 OF 10
AX With Number	DOCUMENT REVISION	REV	DRAW													
	SPH_Labels	A	3 OF 10													
	1	2	3	4	5	6	7	8								

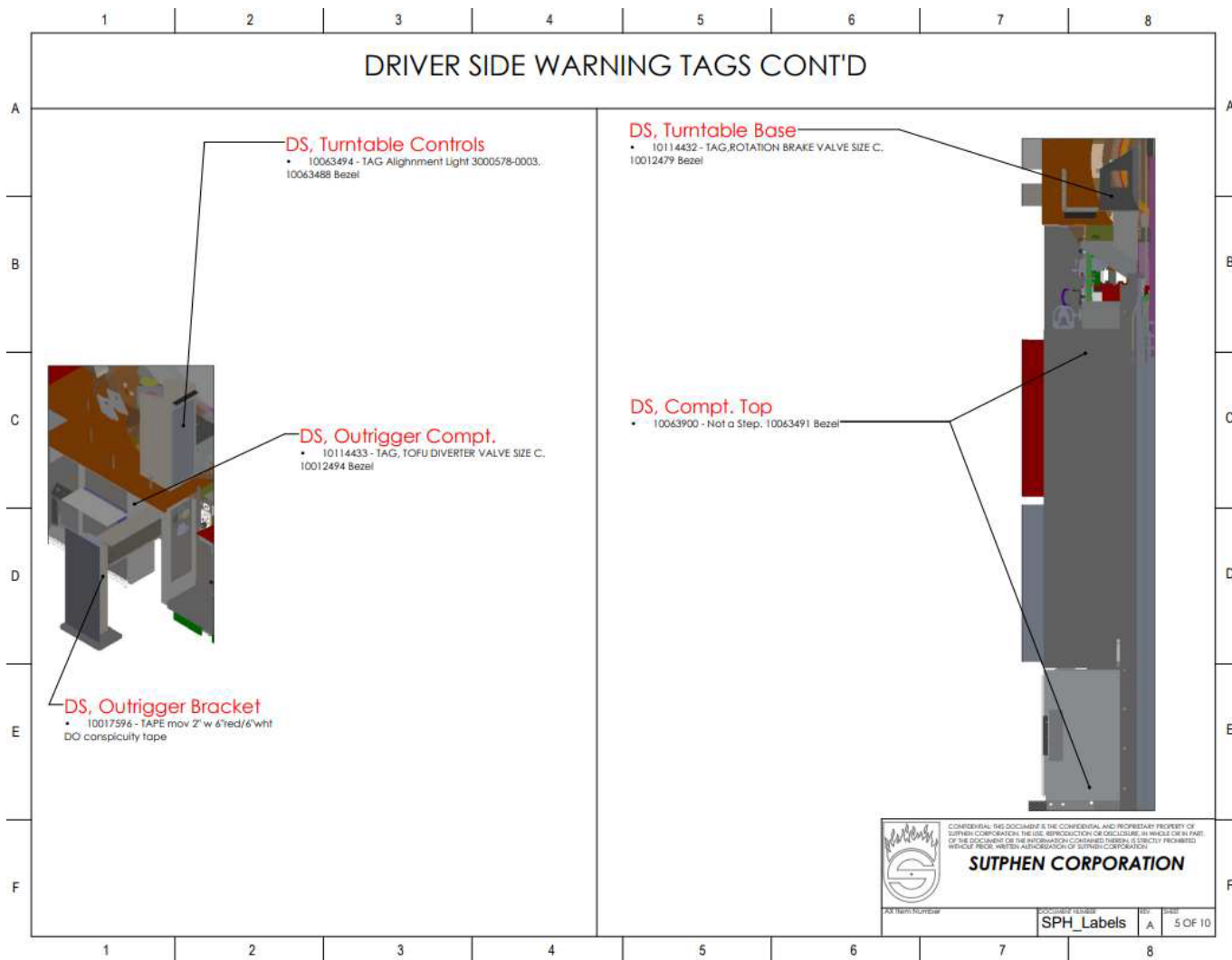

Operator Manual

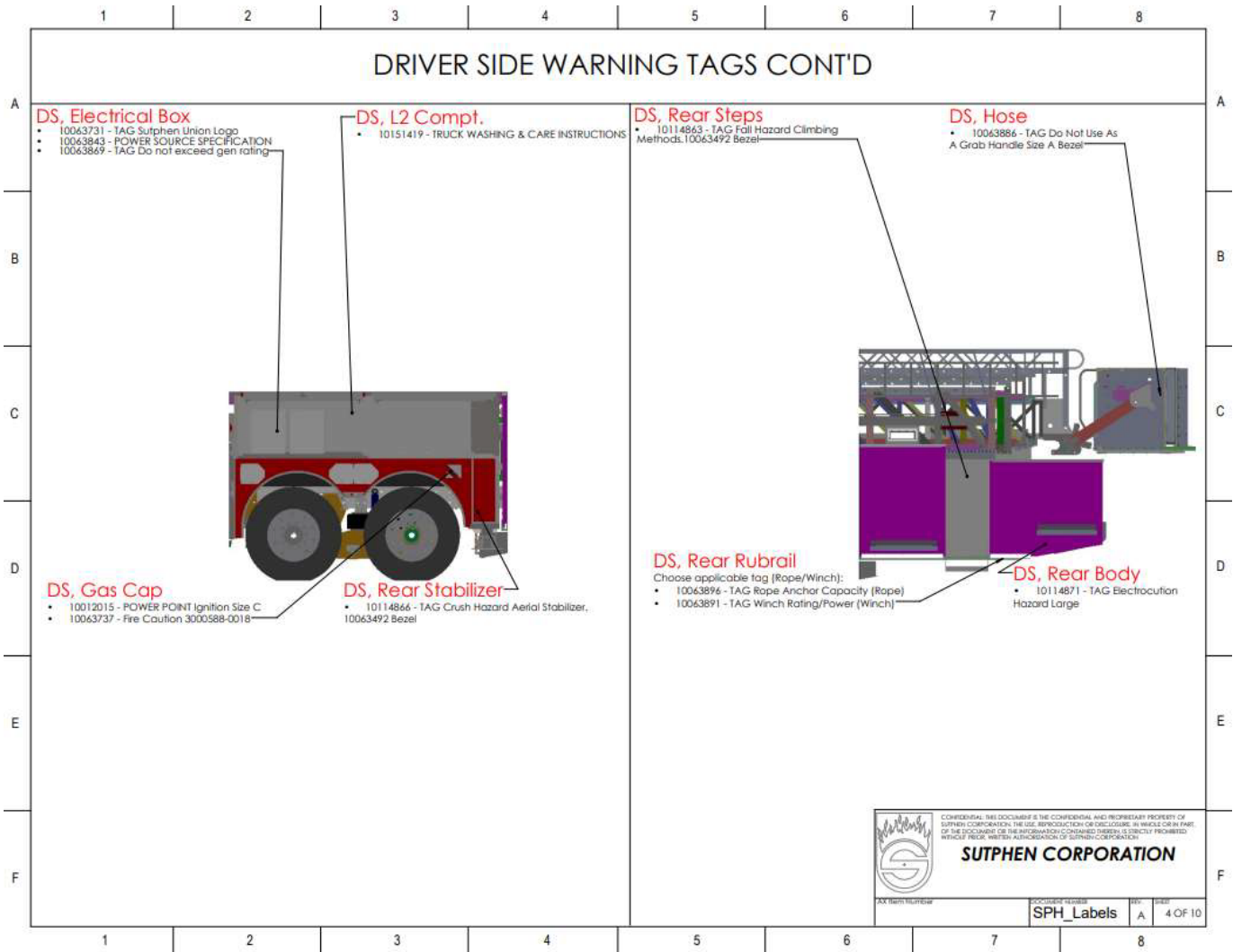

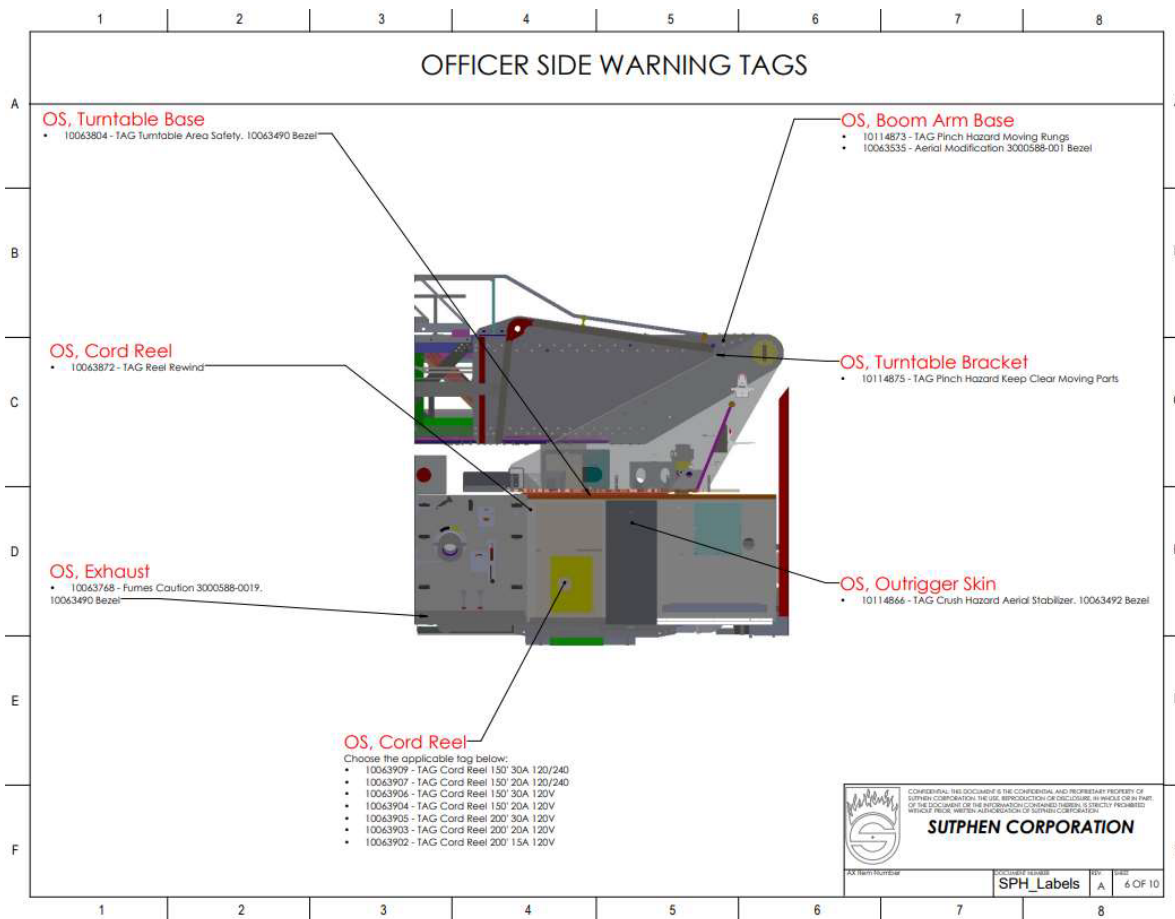

Operator Manual

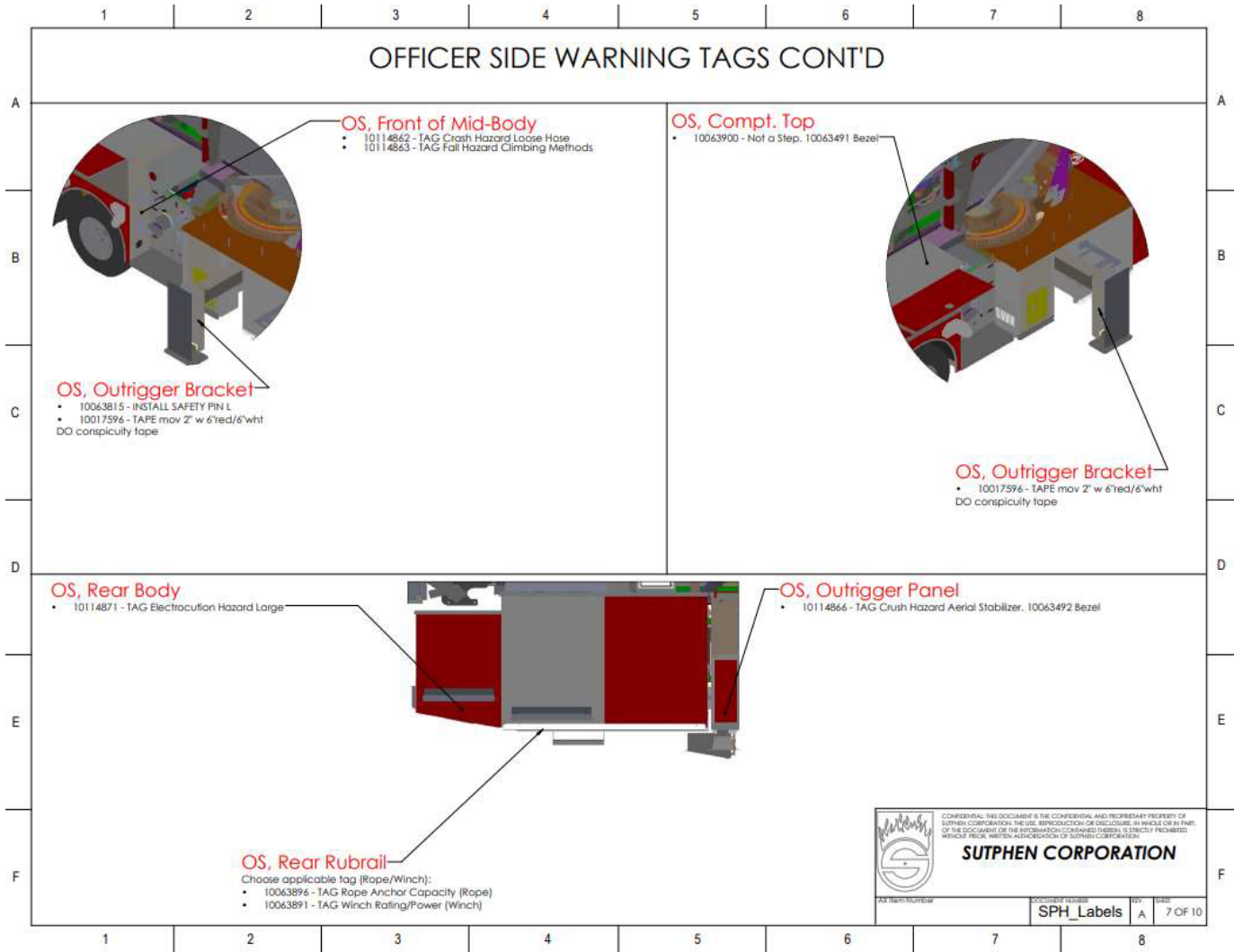

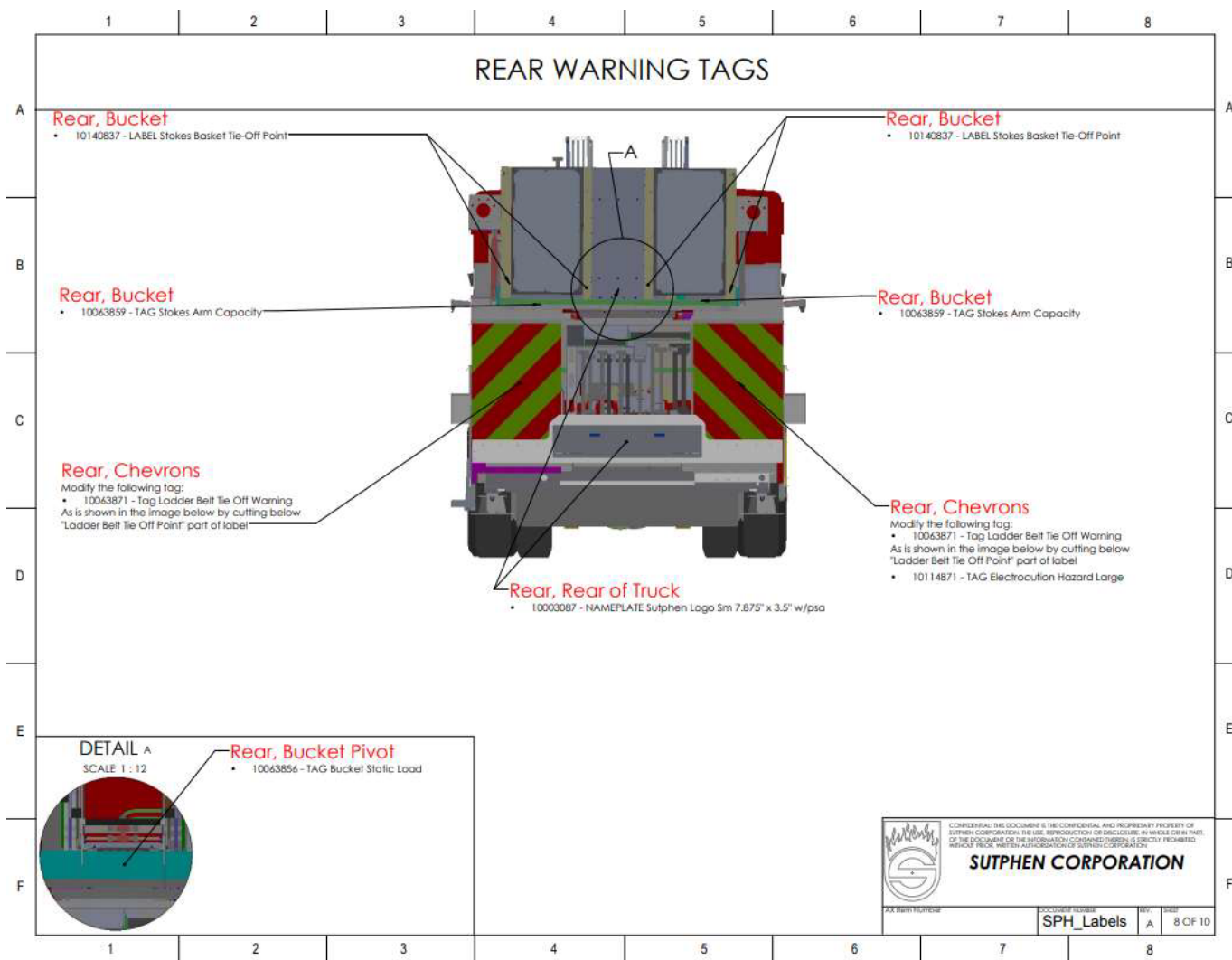

Operator Manual

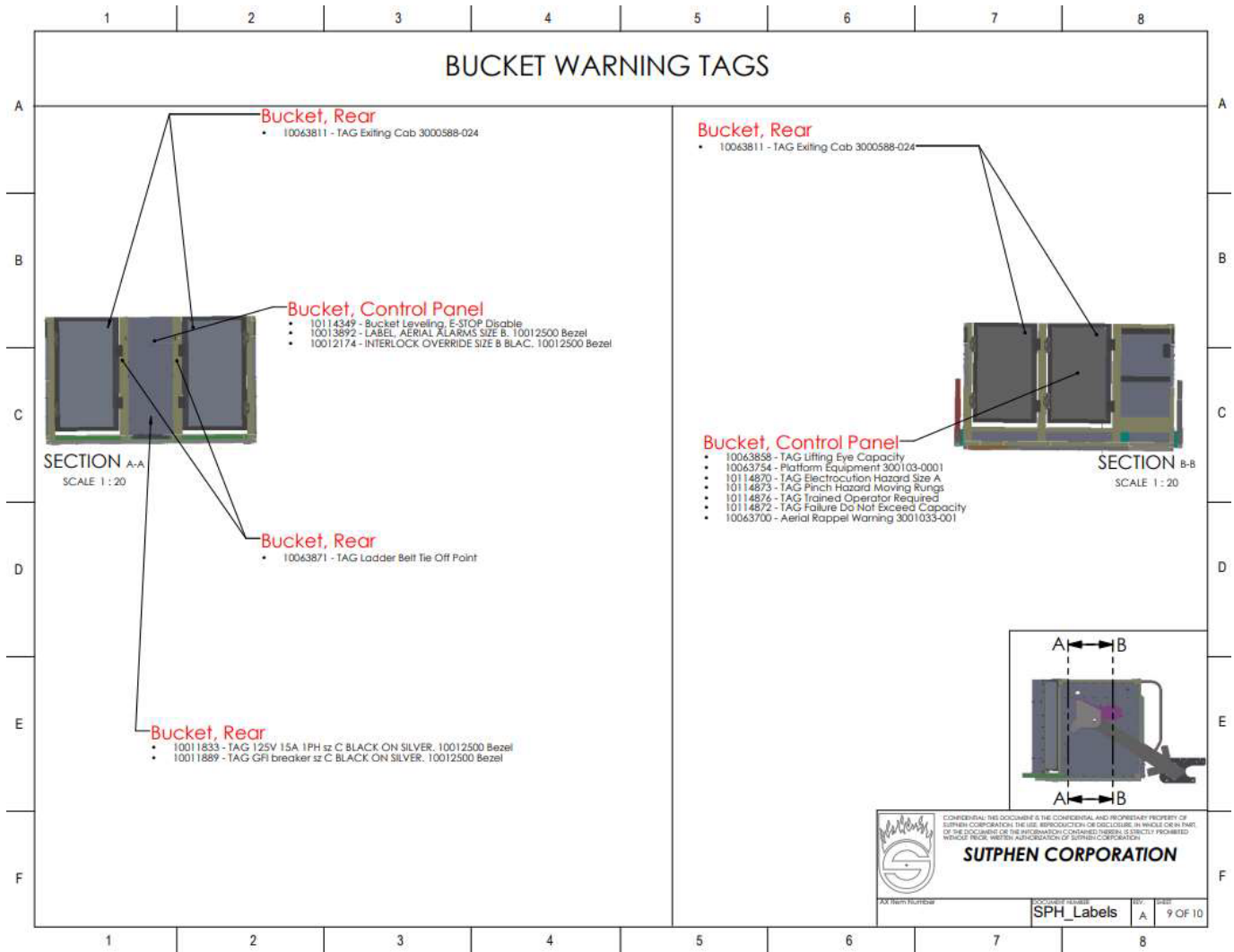

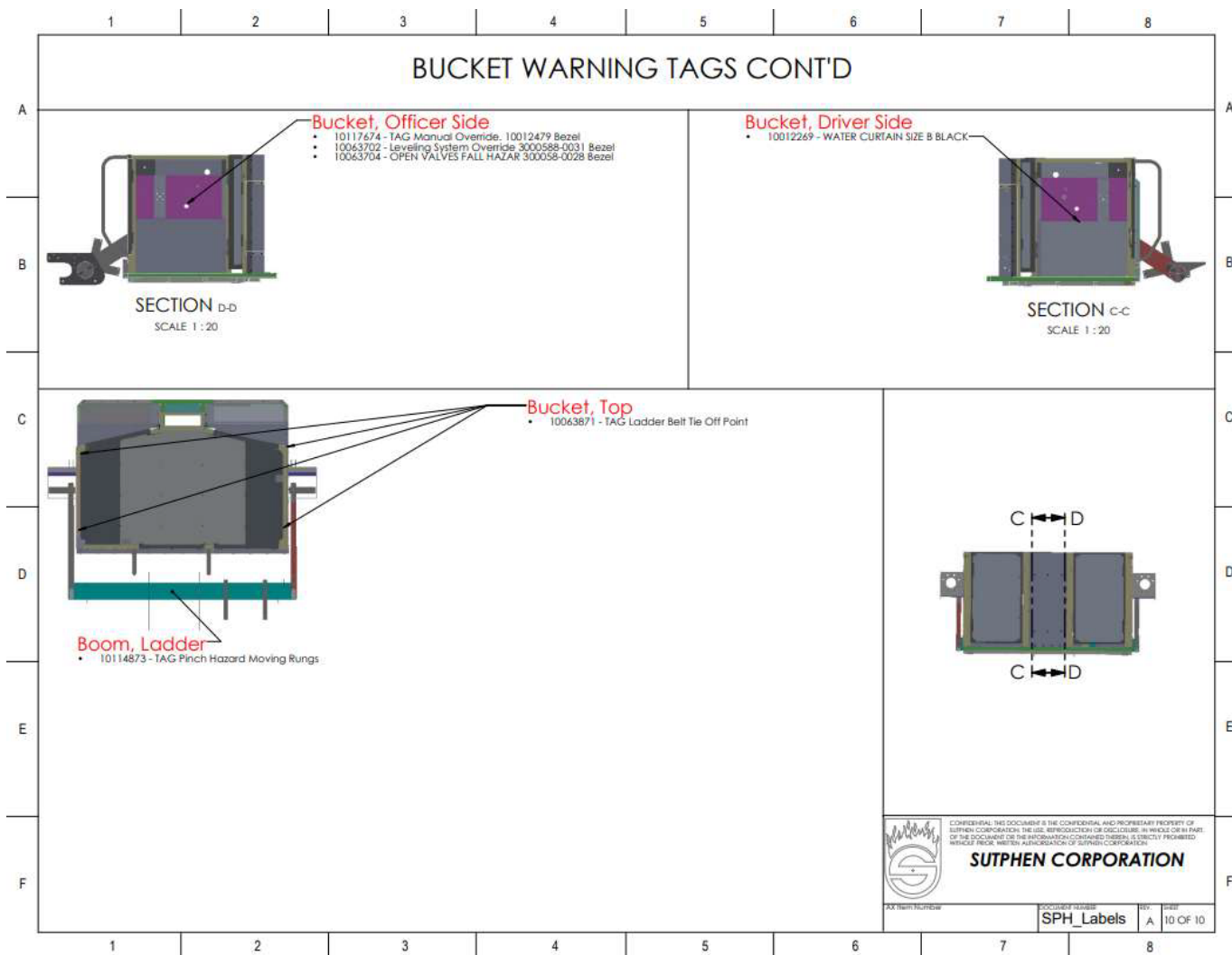

Operator Manual

SPH-100 WARNING TAGS		
Location	TAG AX NUMBER DESCRIPTION	BEZEL
DRIVER SIDE WARNING TAGS		
Driver Side, Front Stairs	10114869 - TAG Fall Hazard Restraint Required	10063488
	10114863 - TAG Fall Hazard Climbing Methods	10063492
	10063874 - TAG sfty instrc raise cab 07	10063489
	10063692 - Lowering Cab Warning	10063491
	10063696 - Cab Tilt 3000584-0001	10063490
Driver Side, Outrigger Control Panel	10063877 - Cab Tilt Safety Switch 07	10063490
	10114867 - TAG Stability Hazard Jack Use Pins	N/A
	10114870 - TAG Electrocutation Hazard Size A	N/A
	10114876 - TAG Trained Operator Required	N/A
	10114866 - TAG Crush Hazard Aerial Stabilizer	N/A
Driver Side, Outrigger Skin	10114866 - TAG Crush Hazard Aerial Stabilizer	10063492
Driver Side, Outrigger Compartment	10114433 -TAG, TOFU DIVERTER VALVE SIZE C	10012494
Driver Side, Jack Control Panel	10063566 - Pinch Point 3000588-021 Bezel D	N/A
Driver Side, Outrigger Bracket	10063815 - INSTALL SAFETY PIN L	N/A
	10017596 - TAPE mov 2" w 6"red/6"wht DO conspicuity tape	N/A
	10003087 - NAMEPLATE Sutphen Logo Sm 7.875" x 3.5" w/psa	N/A
Driver Side, Turntable Control	10114870 - TAG Electrocutation Hazard Size A	N/A
	10114872 - TAG Failure Do Not Exceed Capacity	N/A
	10114867 - TAG Stability Hazard Jack Use Pins	N/A
	10114865 - TAG Safety Trained Personnel Only	N/A
	10151251 - LABEL, VERTICAL ON/OFF SIZE C WITH ARROW	10012479
	10114874 - TAG Inspection Required	N/A
	10063494 - TAG Alignment Light 3000578-0003	10063488
Driver Side, Boom Arm Base	10114873 - TAG Pinch Hazard Moving Rungs	N/A
	10063535 - Aerial Modification 3000588-001	N/A
Driver Side, Turntable Base	10063804 - TAG Turntable Area Safety	10063490
	10114875 - TAG Pinch Hazard Keep Clear Moving Parts	10063490
	10114432 - TAG, ROTATION BRAKE VALVE SIZE C	10012479
Driver Side, Turntable Bracket	10114875 - TAG Pinch Hazard Clear Moving Parts	N/A
Driver Side, Front of Mid-Body	10114862 - TAG Crush Hazard Loose Hose	N/A
	10114870 - TAG Electrocutation Hazard	N/A
	10114865 - TAG Safety Trained Personnel Only	N/A
	10114863 - TAG Fall Hazard Climbing Methods	N/A
Driver Side, L2 Compartment	10151419 - TRUCK WASHING & CARE INSTRUCTIONS	N/A
	10063731 - TAG Sutphen Union Logo	N/A
	10063843 - POWER SOURCE SPECIFICATION	N/A
	TAG Do not exceed gen rating	N/A
Driver Side, Gas Cap	10012015 - POWER POINT Ignition Size C	N/A
	10063737 - Fire Caution 3000588-0018	N/A
Driver Side, Rear Stabilizer	10114866 - TAG Crush Hazard Aerial Stabilizer	10063492
Driver Side, Rear Steps	10114863 - TAG Fall Hazard Climbing Methods	10063492
Driver Side, Rear Rubrail	10063896 - TAG Rope Anchor Capacity	N/A
	10063891 - TAG Winch Rating/Power	N/A
Driver Side, Rear Body	10114871 - TAG Electrocutation Hazard Large	N/A
Driver Side, Hose	10063886 - TAG Do Not Use As A Grab Handle Size A Bezel	N/A
Driver Side, Compartment Top	10063900 - Not a Step	10063491



OFFICER SIDE WARNING TAGS		
Officer Side, Boom Arm Base	10114873 - TAG Pinch Hazard Moving Rungs	N/A
	10063535 - Aerial Modification 3000588-001	N/A
Officer Side, Turntable Base	10063804 - TAG Turntable Area Safety	10063490
Officer Side, Turntable Bracket	10114875 - TAG Pinch Hazard Keep Clear Moving Parts	N/A
Officer Side, Outrigger Bracket	10063815 - INSTALL SAFETY PIN L	N/A
	10017596 - TAPE mov 2" w 6"red/6"wht DO conspicuity tape	N/A
Officer Side, Outrigger Skin	10114866 - TAG Crush Hazard Aerial Stabilizer	10063492
Officer Side, Cord Reel	10063909 - TAG Cord Reel 150' 30A 120/240	N/A
	10063907 - TAG Cord Reel 150' 20A 120/240	N/A
	10063906 - TAG Cord Reel 150' 30A 120V	N/A
	10063904 - TAG Cord Reel 150' 20A 120V	N/A
	10063905 - TAG Cord Reel 200' 30A 120V	N/A
	10063903 - TAG Cord Reel 200' 20A 120V	N/A
	10063902 - TAG Cord Reel 200' 15A 120V	N/A
	10063872 - TAG Reel Rewind	N/A
Officer Side, Exhaust	10063768 - Fumes Caution 3000588-0019	10063490
Officer Side, Front of Mid-Body	10114862 - TAG Crash Hazard Loose Hose	N/A
	10114863 - TAG Fall Hazard Climbing Methods	N/A
Officer Side, Rear Stabilizer	10114866 - Crush Hazard Aerial Stabilizer	10063492
Officer Side, Rear Rubrail	10063896 - TAG Rope Anchor Capacity	N/A
	10063891 - TAG Winch Rating/Power	N/A
Officer Side, Rear Body	10114871 - TAG Electrocutation Hazard Large	N/A
REAR WARNING TAGS		
Rear, Bucket	10140837 - LABEL Stokes Basket Tie-Off Point	N/A
	10063859 - TAG Stokes Arm Capacity	N/A
Rear, Chevrons	10063871 - TAG Ladder Belt Tie-Off Warning	N/A
	10114871 - TAG Electrocutation Hazard Large	N/A
Rear, Bucket Pivot	10063856 - TAG Bucket Static Load	N/A
Rear, Rear of Truck	10003087 - NAMEPLATE Sutphen Logo Sm 7.875" x 3.5" w/psa	N/A
BUCKET WARNING TAGS		
Bucket, Rear	10063811 - TAG Exiting Cab 3000588-024	N/A
	10063871 - TAG Ladder Belt Tie-Off Warning	N/A
	10011833 - TAG 125V 15A 1PH sz C BLACK ON SILVER	10012500
	10011889 - TAG GFI breaker sz C BLACK ON SILVER	10012500
	10063858 - TAG Lifting Eye Capacity	N/A
	10063754 - Platform Equipment 300103-0001	N/A
	10114870 - TAG Electrocutation Hazard Size A	N/A
	10114873 - TAG Pinch Hazard Moving Rungs	N/A
	10114876 - TAG Trained Operator Required	N/A
	10114872 - TAG Failure Do Not Exceed Capacity	N/A
	10063700 - Aerial Rappel Warning 3001033-001	N/A
Bucket, Control Panel	10114349 - Bucket Leveling, E-STOP Disable	N/A
	10013892 - LABEL, AERIAL ALARMS SIZE B	10012500
	10012174 - INTERLOCK OVERRIDE SIZE B BLAC	10012500
	10134891 - LABEL, BREATHING AIR ALARM	N/A
Bucket, Officer Side	10117674 - TAG Manual Override	10012479
	10063702 - Leveling System Override 3000588-0031 Bezel	N/A
	10063704 - OPEN VALVES FALL HAZAR 3000588-0028 Bezel	N/A
Bucket, Driver Side	10012269 - WATER CURTAIN SIZE B	N/A
Bucket, Top	10063871 - TAG Ladder Belt Tie-Off Warning	N/A
Bucket, Ladder	10114873 - TAG Pinch Hazard Moving Rungs	N/A

1.4 Cab Setup Procedures

Locating the Vehicle

1. Spot the rig about 30 to 35 feet from the building when possible. This will give you maximum vertical coverage of the building.
2. Set the parking brake.
3. Place the transmission in neutral.
4. Make sure apparatus is on firm pavement, and that it is clear of overhead obstacles, such as poles, trees, wires, building overhang, etc.
5. Make sure that the outriggers or rear jacks are not going to sit upon manhole covers, drains, or grates in the street or on sidewalks.
6. Good judgement must be used in locating the apparatus at the fire scene. Ideal conditions may not always exist, so caution must be used to determine as safe a location as possible for the apparatus.

Activating the Hydraulic System

There is a PTO which operates the hydraulic pump, providing hydraulic pressure to the system.

1. Engine must be at idle RPM.
2. Be sure there is at least 90 lbs of air pressure on truck air system.
3. Truck must be at complete stop, parking brake set, and transmission in neutral (N).
4. Flip rocker switch for Aerial PTO. A pilot light (1) will come on when the PTO is engaged.

The cab controls are now set to operate the hydraulic system.

Refer to the following schematic for troubleshooting.

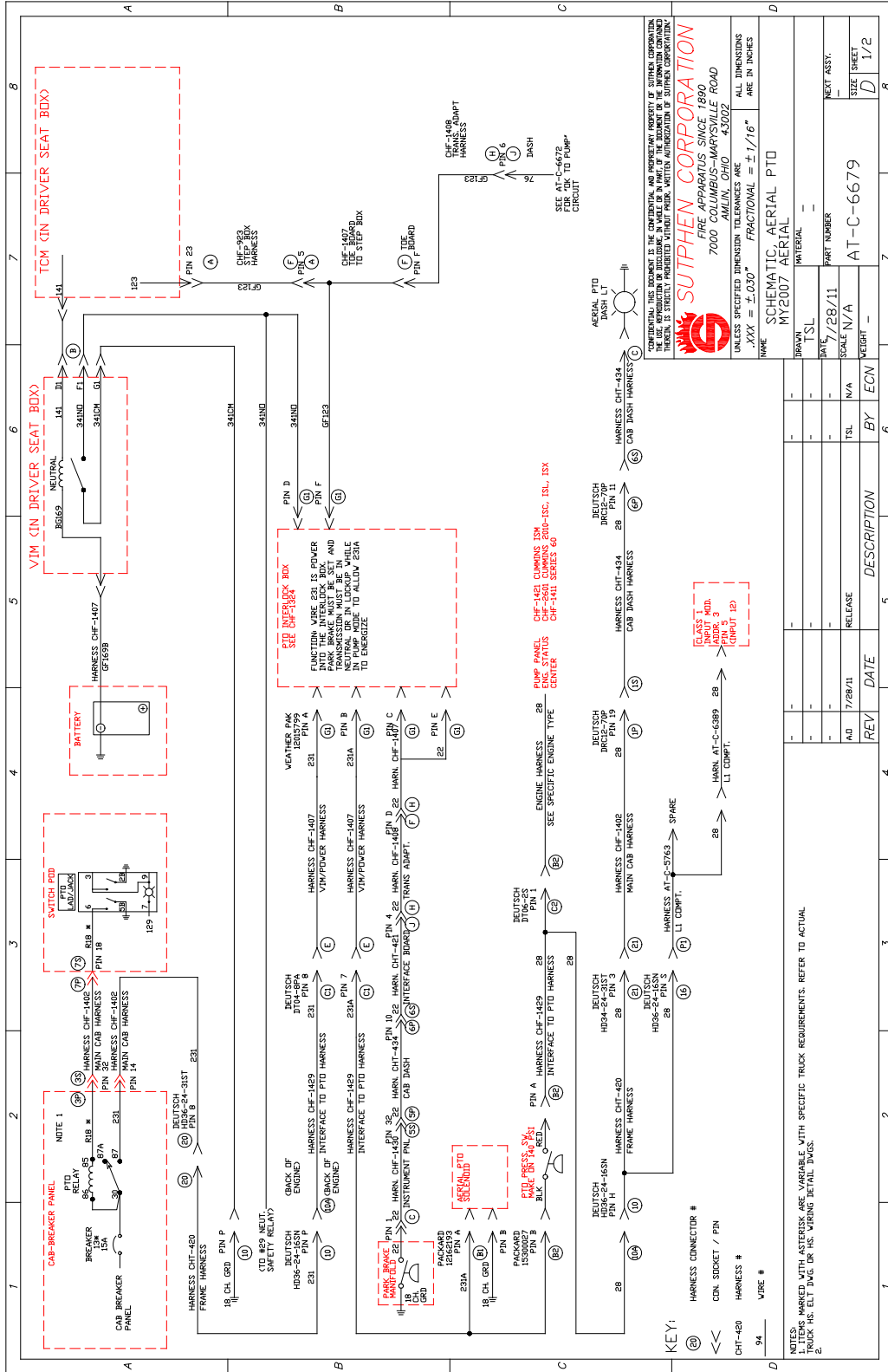

Operator Manual

If not using the fire pump, or if your vehicle does not have a fire pump, proceed to **AERIAL TOWER SETUP** found later in these instructions.



Mode Button and Pilot Light (1) for Generator PTO

1.5 Cab Setup for Fire Pump Operation

NOTE: See **Fire Pump Manual** for more detailed information.

1. Truck must be stopped and parking brake set.
2. Truck transmission must be in neutral (N) position.
3. Engine must be at idle RPM.
4. Move the pump shift lever from ROAD position to PUMP position. This is done by raising the yellow locking collar and pulling back on the lever. Notice the green PUMP ENGAGEMENT light will come on. Pause in the middle to let air exhaust in between shifting.



Air Pump Shift



Electronic Pump Shift

Pump Shift Lever

5. (Only if the pump is wet)

Shift transmission to drive (D) (1-4) position. Power from the engine is now being transferred to the pump drive gear and pump impellers are turning. Observe the second illuminated green OK TO PUMP indicator light next to the shift lever. The lock-up for the automatic transmission will be engaged when the transmission is shifted into drive (D). The pump shift lever will hold the transmission in the pumping gear position.

If the light is not on, the pump is not engaged. Repeat steps 1-5 and observe for pump engagement.

6. To have the pump ready for operation later, leave transmission selector in neutral (N). For pump operation, simply put transmission selector in drive (D) (1-4).

NOTE: Upon arrival at a structure fire or other incident where the tower is not immediately needed, but the fire pump is being used, it is a good practice to place the PTO in gear before placing the fire pump in gear. Should a need to use the tower arise, and the fire pump is being used, the stabilizers can be set, and the tower is then ready for immediate use. If the PTO was not engaged before the pump was set up, it would be necessary to slow the engine to an idle to engage the PTO, jeopardizing fire fighting operations.

Refer to the following schematics for troubleshooting.

Operator Manual

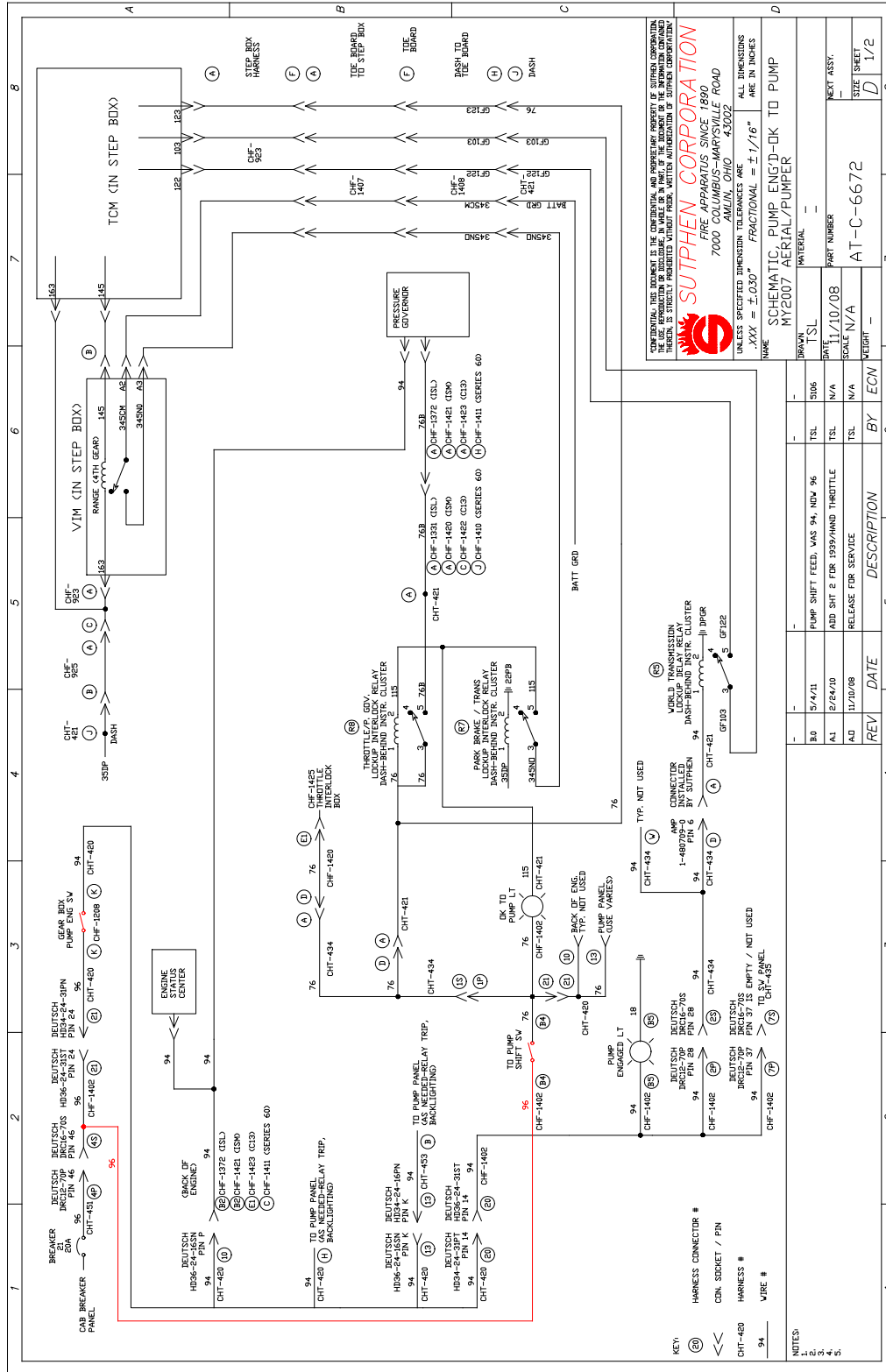

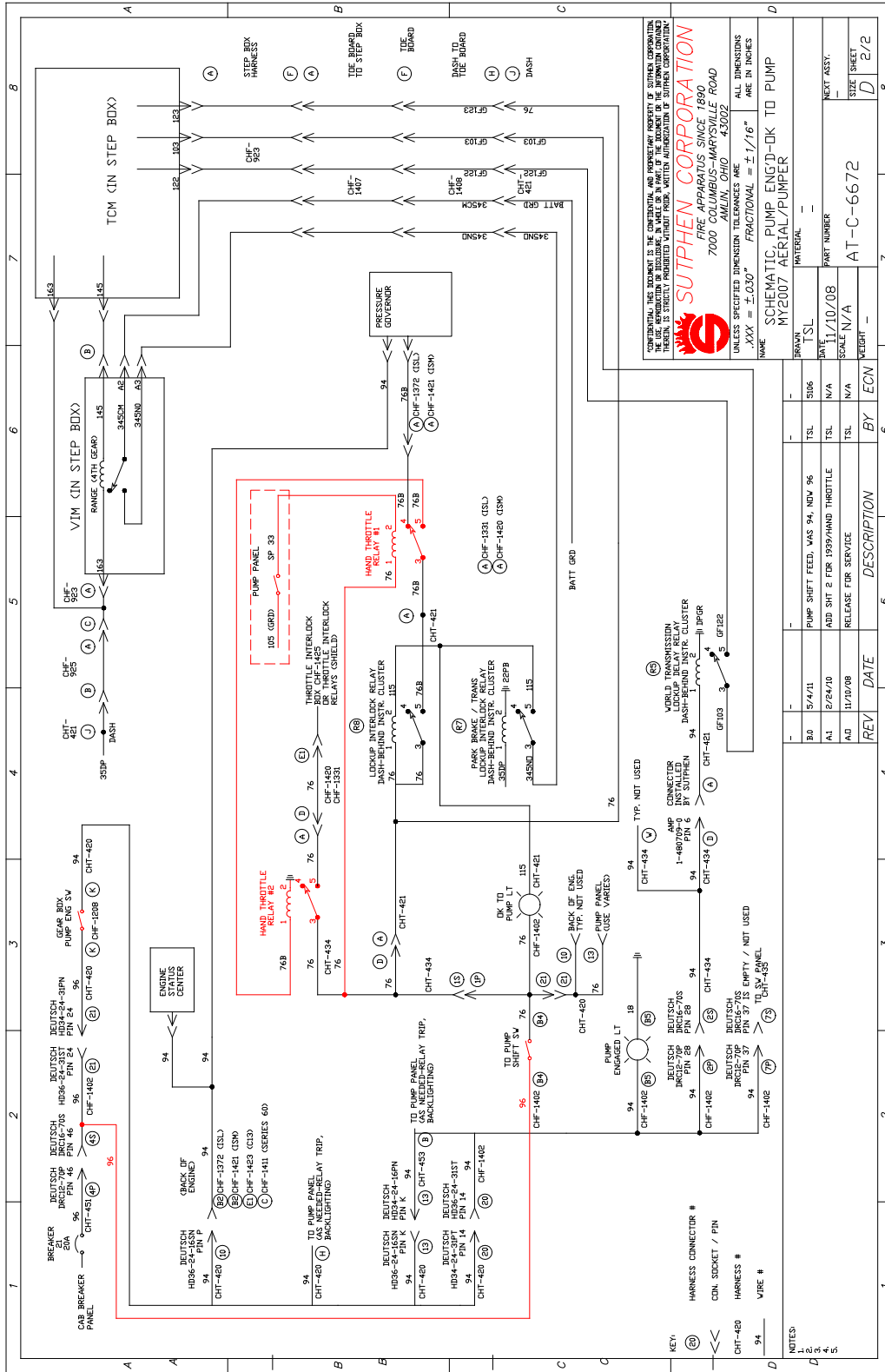

CONFIDENTIAL: THIS DOCUMENT IS THE CONFIDENTIAL AND PROPRIETARY PROPERTY OF SUTPHEN CORPORATION. THE USE, REPRODUCTION OR DISCLOSURE IN WHOLE OR IN PART OF THE CONTENT OF THIS DOCUMENT CONTAINED HEREIN IS STRICTLY PROHIBITED WITHOUT PRIOR WRITTEN AUTHORIZATION OF SUTPHEN CORPORATION.

SUTPHEN CORPORATION
 FIRE APPARATUS SINCE 1890
 7000 COLUMBUS-MARYSVILLE ROAD
 ARLIN, OHIO 43002

UNLESS SPECIFIED DIMENSION TOLERANCES ARE: ALL DIMENSIONS ARE IN INCHES
 .XXX = ±.030 FRACTIONAL = ±1/16"

NAME: SCHEMATIC, PUMP ENG'D-DK TO PUMP AERIAL/PUMPER
 MATERIAL: TSL
 DRAWN: TSL
 DATE: 11/10/08
 PART NUMBER: N/A
 SCALE: N/A
 NEXT ASSY: AT-C-6672
 SHEET: D 2/2

REV	DATE	DESCRIPTION	BY	EON
80	5/4/11	PUMP SHFT FEED, WAS 94, NEW 96	TSL	S106
A1	2/24/10	ADD SHIT 2 FOR 1999/HAND THROTTLE	TSL	N/A
A0	11/10/08	RELEASE FOR SERVICE	TSL	N/A

- KEY:
- (A) HARNESS CONNECTOR #
 - (B) CON. SOCKET / PIN
 - (C) HARNESS #
 - (D) WIRE #
- NOTES:
1. TO PUMP PANEL
 2. TO PUMP PANEL RELAY TRIP, BACKLIGHTING
 3. TO PUMP PANEL RELAY TRIP, BACKLIGHTING
 4. TO PUMP PANEL RELAY TRIP, BACKLIGHTING
 5. TO PUMP PANEL RELAY TRIP, BACKLIGHTING

Operator Manual

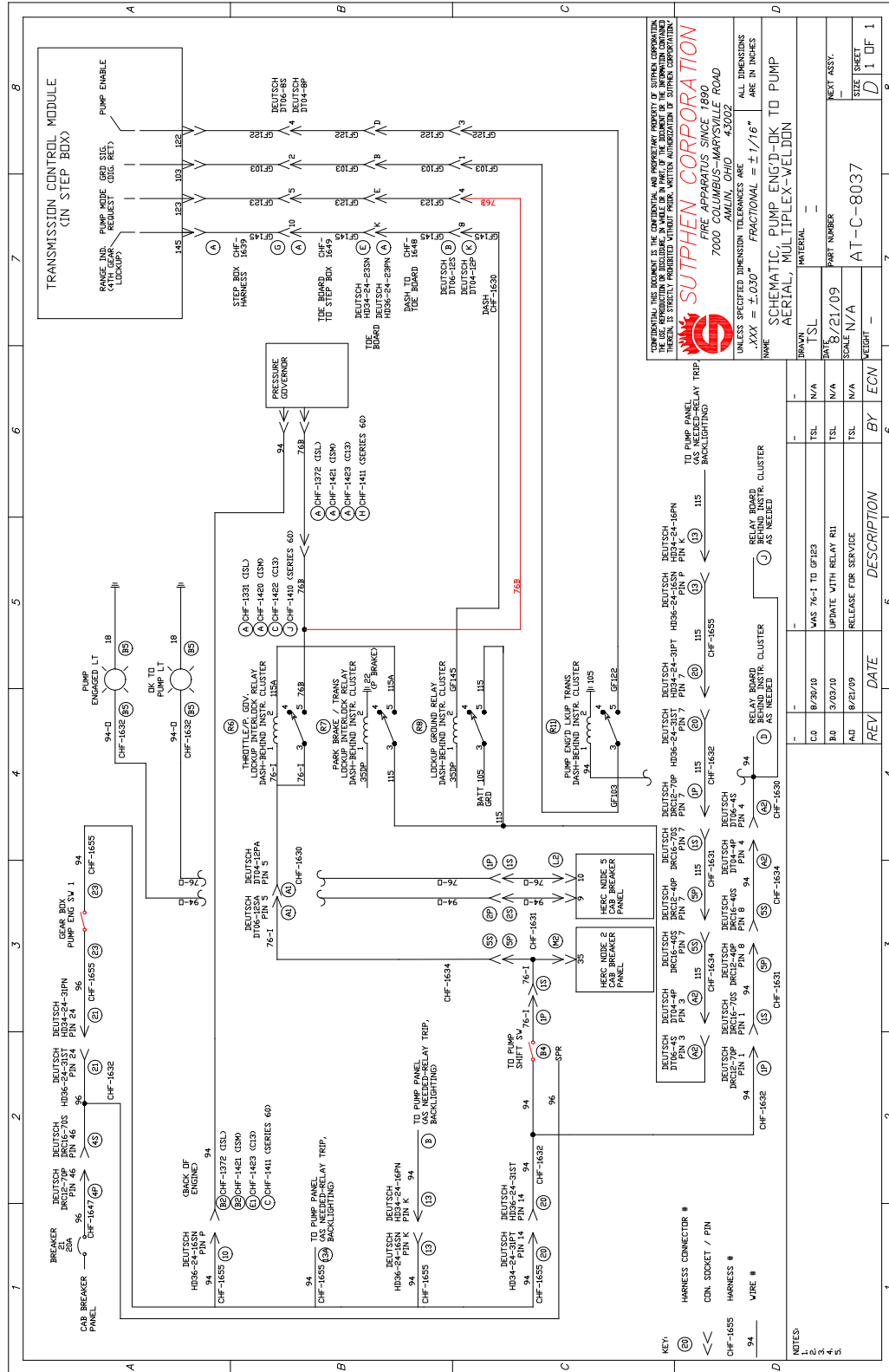

CONFIDENTIAL THIS DOCUMENT IS THE CONFIDENTIAL AND PROPRIETARY PROPERTY OF SUTPHEN CORPORATION. IT IS TO BE KEPT SECRET AND NOT TO BE DISCLOSED TO ANY OTHER PERSON OR ENTITY WITHOUT THE WRITTEN PERMISSION OF SUTPHEN CORPORATION.

SUTPHEN CORPORATION
 FIRE APPARATUS SINCE 1890
 7000 COLUMBUS-MARYSVILLE ROAD
 COLUMBUS, OH 43002

ALL DIMENSIONS ARE IN INCHES
 UNLESS SPECIFIED DIMENSION TOLERANCES ARE ±0.005"
 FRACTIONAL = ±1/16"

NAME: SCHEMATIC, PUMP ENG'D-OK TO PUMP AERIAL, MULTIPLEX-WELDLINE
 DRAWN: TSL
 PART NUMBER: 8/21/09
 SCALE: N/A
 AT-C-8037
 ECN: -
 BY: -
 DATE: -
 DESCRIPTION: -



1.6 Aerial Setup Procedures

Your Sutphen Aerial Platform has been designed to work in out-of-level conditions (See section 1.7.10 and 1.7.12 below for details). You can work in high winds up to 35 miles per hour. The aerial can shed ice buildup caused by freezing rain and/or nozzle spray.

1.7 Stabilizing System

This system consists of eight double-acting hydraulic cylinders. Two of the cylinders permit the extension of the main outriggers to be located in such a manner as to allow for curbs, potholes, alleys or narrow locations between other vehicles. All cylinders are provided with double pilot-operated check valves to ensure constant holding position of any outrigger after it has been set in position. The main stabilizers (outriggers) are provided with large steel feet that swivel to allow them to adjust to the contour of the ground surface. Auxiliary ground jack pads are provided for the outriggers and should be used every time the tower is set up. A front jack system is provided on all models.



DANGER

Always set up the apparatus on concrete, blacktop, or gravel. Surface must be firm and solid. Soil/ground surfaces are not desirable, as the outrigger may sink into the ground causing a tipover. Soil surfaces that seem stable upon setup may erode with fire scene runoff water, thus making them unstable. Asphalt parking lot surfaces are typically thin and in hot weather may allow the outrigger to sink through, especially if the subsurface material is sand.

Ground Jack Controls

1. Move to the ground jack controls, located in the compartment directly behind the cab on the driver's side of the truck.
2. There are six switches or handles (Ref. 1) for the hydraulic control valves to operate the outriggers/jacks.
3. Look at the level indicator located on the rear of the cab to see how far out-of-level the apparatus is.

Operator Manual

- 4. There is a switch labeled HYD. TRANSFER - OFF (Ref. 2) for jack operation and ON for aerial operations.



Jack Controls



5. Making sure all is clear, extend the left-hand outriggers to the maximum extension. As the outriggers start out, a warning alarm will sound and the JACKS NOT SET (Ref. 2) text box on the turntable pedestal will illuminate. This indicates that the jack system is not properly deployed but will silence, and the text box light will go out, when you complete the setup procedure.



Pedestal Control Panel

▽ **Operator Manual**

6. Making sure all is clear, extend the right-hand outrigger to the maximum extension, observing the area through the large mirror provided on the rear of the cab. Although one person can perform this operation, it is safer and quicker to have someone else on the right side of the apparatus.



View of Right Outrigger in Mirror



7. Remove the auxiliary ground pads from their carriers under the front compartments and place them directly under each outrigger foot.



Auxiliary Pad Under Outrigger



DANGER

Auxiliary ground pads must be free of cracks and placed under outrigger feet at all times. Failure to do so could result in a tipover causing serious injury or death and/or damage to the vehicle. Never put wood or plastic jack pads down for rear jacks; use only metal for grounding.

8. Lower the left outrigger until it touches the auxiliary ground pad.
9. Lower the right outrigger until it touches the auxiliary ground pads. View from mirror or spotter.
10. Level the truck from **side-to-side**, if necessary, to work in a range of 5 degrees out of level as indicated by the green area on the level indicator on the rear of the cab. As long as the level is in the green area, you are allowed to operate.
11. Push and hold both left and right outrigger down switches / handles simultaneously to raise the front of the truck until the front tires clear the ground (1") one inch. If using Hendrickson Suspension, lower the outriggers until the bulge is out of the front tires.

12. Lower the rear jacks so that the tires on the front axle just touch the ground. Note: Full extension may not be necessary for the tires to just touch the ground. If using Hendrickson Suspension, lower rear jacks until bulge is back in front tires

NOTE: At this point, the front tires should have come down to where they are just touching the ground. If using Hendrickson Suspension, at this point, there should be a bulge in the tires.

If working on a surface that is not level in the longitudinal axis of the truck, use the outriggers and the rear jacks to level the truck as much as possible. You can work within 10 degrees of the longitudinal axis, as shown on the level indicator at the turntable

NOTE: The above setup procedures are for ideal conditions on flat, level surfaces. If the truck is headed uphill, the front tires will be pressed farther into the pavement and if setup is headed downhill, the front tires may be off the ground.

13. Your apparatus is equipped with cab (axle) jacks, which are two cylinders mounted to the chassis frame in the front wheelwell that push against the front axle. Push the front jack switch to fully extend them, which will isolate the front suspension.



1.8 Safety Pins

Install the pins only after the apparatus has been completely set up properly. The operator and his/her assistant are to show the pins to each other in the mirror before installing them.

Place the outrigger safety pins (1) in the lowest possible hole in the outrigger jack frames. The pins must be installed per instructions, as this completes the interlock system and allows power to be transferred to the upper controls.



Installed Safety Pin

If the safety pin hole is near (1/2" or less) to the safety bar, go up to next higher hole. This will avoid having the pin pinched by cylinder creep that will later not allow you to remove pin when taking down the truck. If it does happen, you must use manual controls under the rear of the cab to operate the jacks. At this point, lower the outriggers until the safety pin is free and remove it.

Operator Manual



DANGER

Always install safety pins on stabilizers. This will guard against a cylinder collapse caused by an internal leak, such as a damaged piston seal.



Proper Hole Selection

NOTE: To prevent needing to use this override procedure, the selection of the next higher hole may be needed when the safety bar is blocking desired pin location. Notice safety bar is level with middle hole. Any one cylinder is allowed 1/2" drift within one-hour standard drift test.

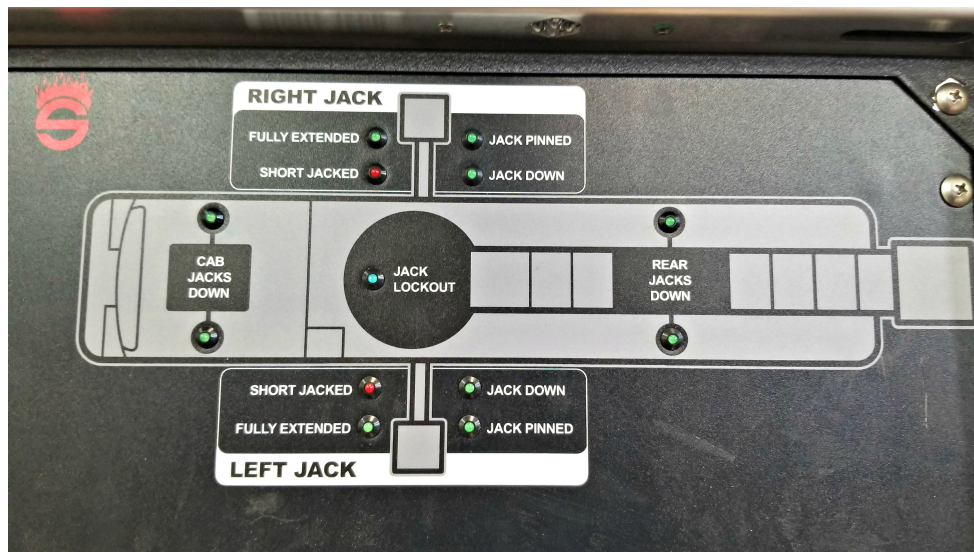

Stabilizer Interlock Display Graphic (1)



NOTE: Once the setup is complete, the warning alarm will automatically silence. The Interlock Display Graphic has individual indicators (LEDs) to show when the individual jack is down. When the jack pair is down (Left and Right, both Rear or both Cab Jacks) the appropriate text box will be on. The Left and Right Jack Pinned text box will be on indicating the individual jack is pinned.

At the pedestal, the JACKS NOT SET text box will go out once the setup is complete (the jacks are fully deployed and pinned).

1.9 Transfer Fluid for Aerial Operation

Push or twist the HYD. TRANSFER switch to transfer the hydraulic fluid to the aerial controls. Fluid is now being pumped to the aerial controls on the turntable and the Jack Lockout text box on the Ground Jack Control panel will be lit indicating the fluid has been transferred.

Activate electrical power to the turntable pedestal by turning the UPPER POWER switch on the Ground Jack Control panel to the ON position.

SAFETY TIP: This switch may be used to disable the platform controls should someone on the ground observe an impending danger to those in the platform that they may not be aware of.

NOTE: This will also shut off power to the intercom system and the platform leveling system. For this reason, it is preferred to use the BUCKET CONTROL POWER switch on the pedestal, which only shuts off power to the platform controls.

With all outriggers and ground jacks properly set as described here, your aerial is designed to operate at its maximum height and horizontal reach with its rated payload without danger of harming personnel or equipment. Precaution must be taken to ensure that the aerial is operated so it does not strike the cab or any other portion of the apparatus during any operation. Water stream reactions may have some affect on certain functions of the tower. This is detailed under Waterway and Nozzles. Power lines should always be observed and avoided at all times.



DANGER

*When operating near power lines, pump operator must stand on the operator's step at all times during tower operation to help prevent operator from becoming the ground in the event tower comes in contact with power lines. Failure to do so could result in **SERIOUS INJURY OR DEATH**.*

Place wheel chocks in front of and behind the front tandem. Place the chock at the outside tires. Do Not place chocks behind rear tandem as damage to the rear jack may occur.



CAUTION

Always remove the chocks before releasing any of the ground jacks. Failure to do so may result in wedging the chock block so tightly against the tire tread that it cannot be removed.



1.10 Stabilizer Interlock System

This stabilizer interlock system is a series of position sensors that are specifically designed to ensure safe and proper set up of the apparatus for aerial operation.

When the outriggers begin to extend, a warning alarm sounds and the JACKS NOT SET box on the pedestal operator panel lights. This indicates that the jack system is not properly set up or properly stowed. The alarm will silence and the JACKS NOT SET will go out when the jack system is properly set up or properly stowed.

When the ground jacks are set up according to the instruction previously found in this manual, one pair of sensors closes when the stabilizers are fully extended and one pair of sensors closes when the outrigger jacks have the safety pins installed.

The closing of these switches produces a signal which allows the aerial to be operated. The initial movement of the aerial from the cradled position locks the fluid transfer so that it cannot be operated again until the aerial is returned to the cradled or stowed position and both safety pins have been removed.

Stabilizer Interlock Override Procedure

Located on the right side of the Ground Jack Control panel, on the front of the bucket controls within the platform and on top of the turntable pedestal are the stabilizer interlock override buttons. They are to be used only in extreme situations where one or both outriggers cannot be fully extended on the side opposite the side you are wanting to operate on. These buttons should be only used by personnel fully trained in the operation of the vehicle. This includes understanding the danger of an overturned vehicle caused by working over an unextended outrigger.

By simultaneously depressing the ground jack control panel's button and either the platform or pedestal buttons, you can raise the aerial from the bed of the truck. After the aerial has cleared the bed and the cradle switch alarm stops sounding, you may let go of the override buttons and the tower will continue to operate. Notice that when the aerial clears the bed, the audible alarm stops, but JACKS NOT SET text box remains on, reminding you that the truck is not set up properly.

After the tower is in operation, great concern shall be given to the position of the tower and shall never be rotated past the longitudinal centerline of the truck towards the "short jacked" side. The short jacked side of the truck should have the outrigger run out as far as possible and have the pad down and pin in.

1.11 Rotation Interlock System

The rotation interlock system will allow the aerial to operate with only one outrigger fully extended on one side and the other side only partially extended. This condition is known as short jacking. This configuration may be required when operating in very narrow areas.

Both outriggers must be lowered properly and the safety pins must be installed properly for the aerial to operate.

In operation, the boom is permitted full unobstructed operation on the side of the fully extended outrigger. Operation is not permitted past the centerline of the truck towards the short jacked side of the truck.

When operating over the properly jacked side of the truck, and you rotate near the longitudinal centerline of the truck, the rotation interlock system will activate audible and visual alarms and put the aerial controls into CREEP MODE. As movement continues, the rotation will stop preventing movement over the short jacked side.

Movement will be allowed back towards the properly fully jacked side.

If, for some reason, the boom has drifted to the short jacked side of the truck, the controls will allow you to rotate back towards the centerline of the truck in whichever direction is closest.



1.12 Smart Boom Warning System

This system will warn you both audibly and visually of impending contact with either the cab or the body of the truck. The boom operation will go into creep mode under these conditions. **It will not stop movement of the boom!**

The system consists of sensors underneath the turntable that determine the radial location of the aerial and adjustable sensors on the left turntable side plate that determine the elevation of the aerial over the cab and rear body.

Located at the turntable pedestal and in the platform are graphic displays for the SMART BOOM WARNING SYSTEM and the ROTATION INTERLOCK SYSTEM. They provide visual indications of the current status of aerial operations.

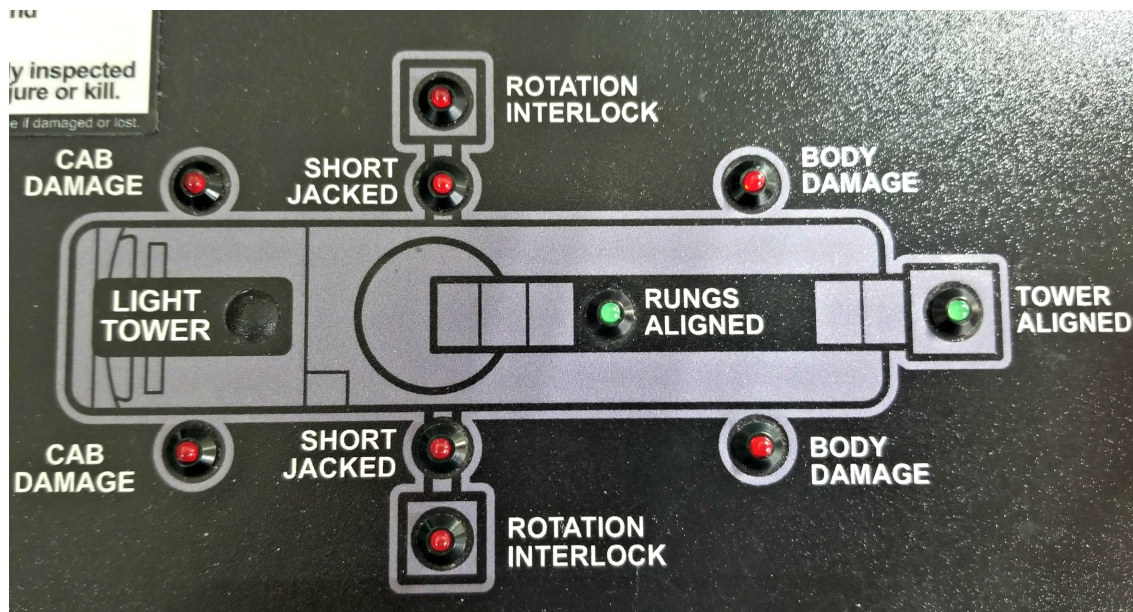

**Pedestal Display Panel of Smart Boom Warning System
and Rotation Interlock System**



Bucket Control Panel

In operation, if the boom is positioned above the cab or body and is lowered to a point that the SMART BOOM WARNING SYSTEM is activated, the aerial controls will be put into a slow motion CREEP MODE and visual and audible alarms will be activated. The aerial controls will remain in CREEP MODE as long as the boom is inside the CONTACT ZONE.

If the boom is in a low elevation over one of the outriggers and is rotated toward the cab or body, the SMART BOOM WARNING SYSTEM will be activated when in close proximity.

When in a CREEP MODE, full operational speed may be regained by either elevating or rotating the boom until it is clear of the CONTACT ZONE.

When a CONTACT ZONE alarm is sounding, you may cancel the audible portion of the alarm by pushing the ALARM SILENCE button. This will cancel the alarm for two minute increments. When the boom is moved to a location outside the CONTACT ZONE, the audible alarm will be automatically reset.



1.13 Aerial Operational Controls



Pedestal Controls



Platform Controls

The aerial may be operated from the turntable pedestal controls (1) or the platform controls (2). The platform and pedestal controls are multiplexed electric over hydraulic.

You will notice that both sets of controls are "proportional", meaning that the operations can be "feathered" to produce gentle movements.

The pedestal controls will always override the platform controls. If the platform operator is moving in one direction, the pedestal operator can stop the operation if an emergency need arises. The power to the platform controls can be turned off at the pedestal or in the ground jack controls.



DANGER

Never operate the tower without first deploying the stabilizer jacks with proper auxiliary ground pads beneath them.

Raise/Lower

Raise the tower by moving the right control lever in the direction indicated.

Lower the tower by moving the right control lever in the direction indicated.

NOTE: Controls in platforms are duplicates of lower controls.

When raising the tower from the cradle, the first motion of the tower should be up, and this should continue until tower is well above the truck.



CAUTION

Observe that tower has cleared the truck body, cab, and lights before rotating. The recommended procedure for aerial operation is a slow, steady movement of the control lever, which will produce a smooth operation.



CAUTION

Rapid movement or jerking of the control levers will result in rough jerking of the aerial imposing excessive loading on the tower structure. This kind of operation is unsafe and will lead to premature wear and, at the extreme, possible structure failure.



DANGER

When raising the aerial, extreme caution should be used near power lines. The operator must observe the tower structure from base to tip to ascertain that the tower is in the clear.

The tower can be elevated from minus 5 degrees to plus 80 degrees from horizontal while in any position of extension.



WARNING

There should be an operator at the lower control station any time the aerial is being used. The lower controls can override the platform controls should an emergency or dangerous situation come up or if the platform operator should become incapacitated because of smoke or other problems.

Extend/Retract

Extend the tower by moving the left control lever in the direction indicated.

Retract the tower by moving the left control lever in the direction indicated.

Rotation

Rotate the tower to the left by moving the center control lever in the direction indicated.

Rotate the tower to the center by moving the right control lever in the direction indicated.

The tower is capable of continuous 360-degree rotation, either to the left or the right.

The operator should never change direction of rotation without first bringing the aerial to a gentle stop.

Fairfield Drive Rotation Brake

General Information

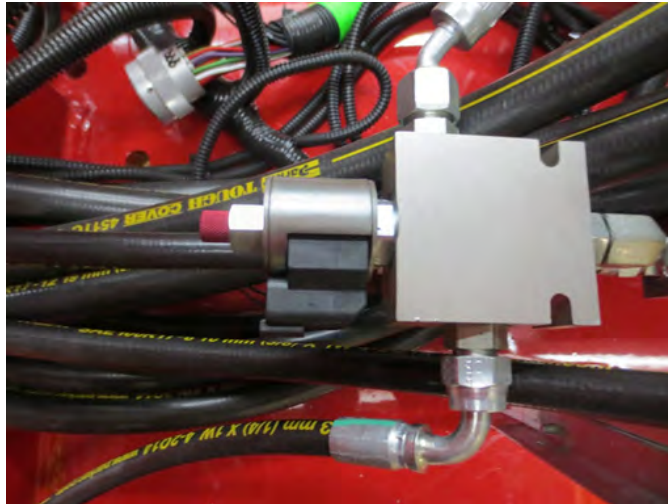

Rotation Brake

The brake valve is plumbed to the rotation drive motors. The purpose of the brake is to hold the aerial in position and not allow the aerial to drift during water flow from the tip of the aerial. The brake also holds the aerial in position when the truck is set up on an incline.

The brake valve is electrically actuated from the Sauer Danfoss base control module. The brake can be released to allow the aerial to rotate using the manual handles for rotation at the pedestal.

NOTE: The brake valve must be returned to normal operation (knob "IN") when the manual rotation handles have finished being used.



Location of The Rotation Brake

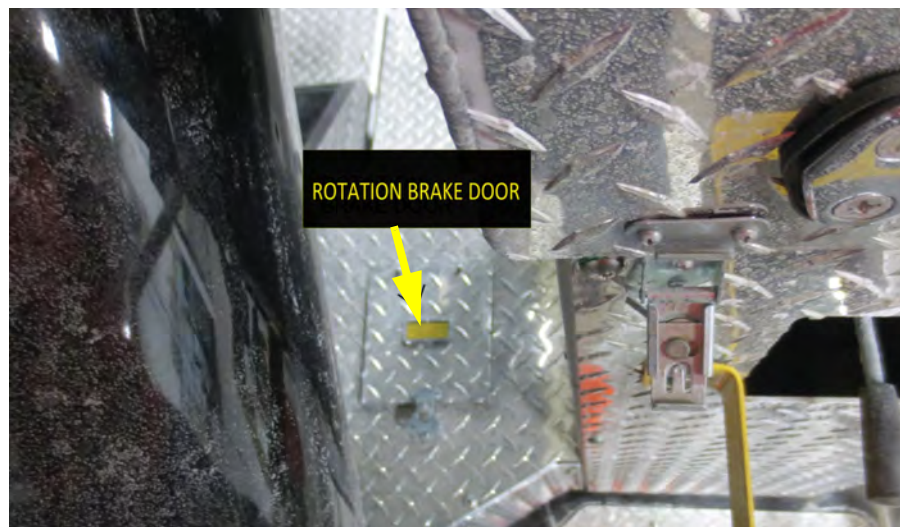

Rotation Brake Door

The rotation brake is located in the tunnel next to the pedestal on the turntable. Access the brake valve knob by opening the rotation brake door.

Releasing the Brake Valve

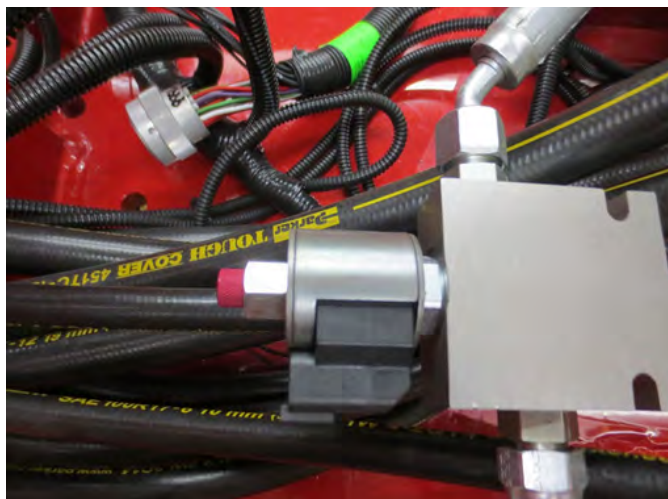

Rotation Brake Valve

The photo shows the rotation brake valve in the tunnel (tunnel covers have been removed for clarity).

▽ **Operator Manual**

The brake valve has a red knurled knob on the end. Normal joystick operation is when the knob is "in". This position will not allow the aerial to drift or move once the brake is on.

To allow the aerial to rotate using the manual handle, the red knob must be "out". This releases the brake.

NOTE: The knob must be twisted and released to pop out.

The knob must be twisted and pushed in to return the brake to normal operation.

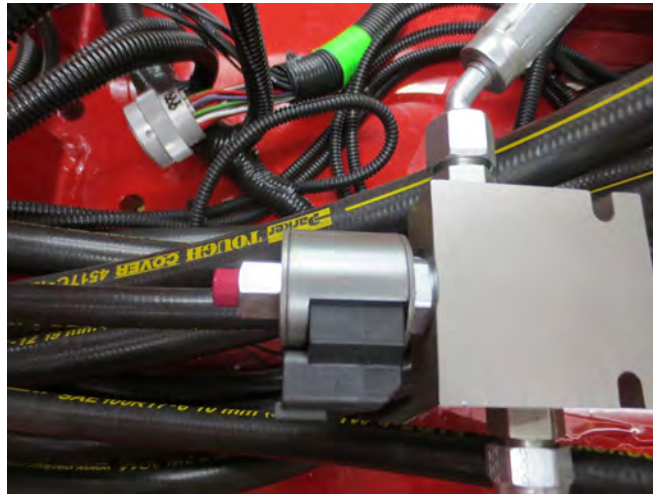

Knob Is In: Joystick Rotation



Knob Is Out: Manual Rotation



High-Speed Control

On the floor of the turntable and on the floor of the platform there is a HI-SPEED switch provided to increase the engine speed and hydraulic pressure simultaneously. This switch is to be used only to increase the speed of operation of the aerial.

There is also a high-speed switch on the Ground Jack Control panel that may be used while operating the outriggers/jacks.



CAUTION

Caution must be used in the use of this HI-SPEED switch.

NOTE: When in pump mode, the switch is disabled.

NOTE: When using the HI-SPEED switch, first have the operational control lever being used in position before engaging the HI-SPEED switch. When coming off HI-SPEED, first release the switch, then release the control lever as desired to complete movement and give a smooth, safe operation.

When extending the aerial and using the HI-SPEED control, be sure to release the HI-SPEED switch before reaching maximum extension. Aerial extension will stop at maximum extension. (There is no signal device for indicating full extension.)

When retracting the aerial and using the HI-SPEED switch, be sure to release the HI-SPEED switch before reaching full retracted position.

NOTE: The aerial is capable of continuous 360-degree rotation to the left or right. If it becomes necessary to rotate at a faster speed, the HI-SPEED switch can be used. Be sure the rotation control lever is engaged before engaging the HI-SPEED switch. When coming off HI-SPEED, release the HI-SPEED switch before releasing the rotational control lever. This will give a nice smooth operation.



CAUTION

While rotating the tower, the operator should not change directions without first permitting the tower to come to a complete stop!

In the event the operator accidentally changes rotation directions without the tower coming to a complete stop, there is a built-in relief valve provided to reduce the shock of such a happening. **IN NO WAY SHOULD THIS BE AN OPERATIONAL PRACTICE!**

Low Range Switch

On the platform control panel there is a switch labeled LOW RANGE. When turned on, this will slow the aerial to approximately half-speed. This can be beneficial when working near obstacles to give you precise control. When activated, both the bucket controls and pedestal controls will be affected.

Auxiliary Hydraulic Power Switch

The auxiliary hydraulic power switch is located on the hydraulic panel. Auxiliary power is used in the event of a main hydraulic pump failure or in case the truck engine fails. It consists of an electric motor, operated from the truck battery system, which operates an auxiliary hydraulic pump.

Operate the motor by turning the auxiliary power switch to the ON position.

All tower functions can be operated on auxiliary power.



CAUTION

Prolonged operation may cause the motor to overheat. The operator should avoid overheating and burning out the motor. If the motor becomes hot, shut down and allow to cool. Failure to do so could result in serious damage to the motor. Run for two minutes and cool for five minutes.



1.14 Water Delivery System

Telescopic Waterway

The waterway through which water from the pump or manifold assembly is transferred to the nozzle is a five-section, telescopic aluminum device. It is located within the tower sections, mounted and cushioned to eliminate any undue stress or strain under tower operating conditions.

The waterway is fed from the pump through the main feed line, coming up through the turntable and passing through a large stainless steel flex tube, which is directly attached to the waterway. Special packing gland seals are provided at the attachment location of each waterway section to ensure constant alignment and eliminate wear to the tubes.

The feed line for the waterway is provided with an electric ball valve at the lower entrance of the water supply. For best results, open and close valve at idle pressure. This is to ensure that no undue water surge is applied to the waterway. A manual override for this valve is provided on the right-side pump panel if your truck has a Hale pump and if your truck has a Waterous pump. In both cases, there is an override located on the Officer's side pump panel that can be used to open the valve.

Two relief valves are installed in the waterway system to help prevent excessive pressure in the waterway (one under the truck and one just behind the platform). Should the operator retract the tower without opening the waterway drain or should pump pressure exceed the capacity of the waterway, the relief valves will open. The lower relief valve is set at 250 psi discharge pressure, and the upper is set at 165 psi. The waterway drain should always be left open when tower is not being operated.

Maintenance is minor and is described in the section under lubrication.



CAUTION

Before retracting the tower, make sure that the nozzles and the waterway drain are open to avoid compressing the water in the waterway. Failure to do so can result in serious damage to the waterway.

Platform Water System

There are two turrets with adjustable stream nozzles provided on each side of the platform. Gear-driven butterfly valves are installed ahead of the turrets to allow smooth control of the water coming to the turrets, eliminating the possibility of surges (water hammer) through the waterway system. The water system is rated for up to 2000 gpm. The rating in the bucket, while waterway is charged or flowing water, is 500 lbs.

Both nozzles may be operated simultaneously or individually. The nozzles are rated to deliver the capacity of the turrets.

There are auxiliary connections on the water system at the platform for standpipe operations. They are 2 ½ inches with a 1 ½-inch reducer and cap. They are controlled by closing the butterfly valve on the turret; then controlling the water flow of these connections with the gate valve ahead of the hose connection.



1.15 Cold Weather Operations

Draining the Waterway

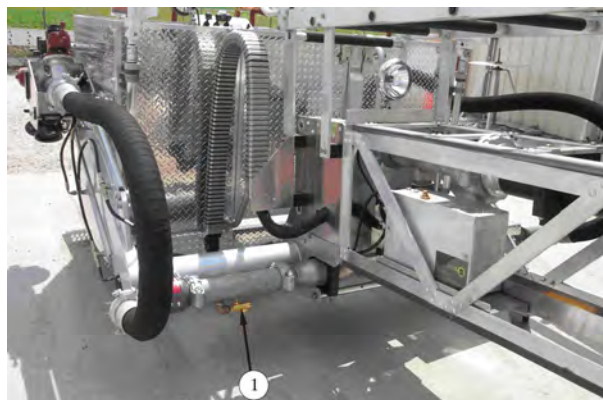

Truck Has Automatic Drain Valve on Yoke



Water Curtain Valve

If operating with your aerial flowing water during freezing conditions, these instructions must be followed for draining the waterway to help prevent potential freezing.

Immediately after shutting off the water flow to the waterway, open the nozzles in the platform, the water curtain (2), and the waterway drain valve (1) (at the pump panel). To expedite the draining process, retract the aerial completely and elevate as high as practical.



CAUTION - Cable Track System

Constant or at least frequent extension and retraction during icing conditions can reduce the possibility of ice forming. Never operate the the ladder when ice has clearly formed or may have formed inside the cable track. Damage may occur if ice builds up inside of the cable track. Ice must be allowed to melt to avoid damaging the cable track system.

1.16 Draining the Fire Pump

Open all master and individual drain valves (suction and discharge) and open all valves, removing caps to make sure they drain completely.

Drain gauges on tower gauge panel.

When pump is completely drained and the apparatus is returned to inside conditions, all individual drains may be shut, but the master drain should be left open until the fire pump is needed to be used.

1.17 Platform Mounting and Leveling System

The platform is suspended in the yoke, anchored on each side with special self-aligning bearings and special high-tensile steel bolts. The bolts that hold the bucket to the yoke have special locking devices to ensure positive, safe operation.

The platform is maintained in a level position relative to the turntable at all times. This is accomplished by a self-contained electro-hydraulic system, eliminating any hydraulic lines up the tower. This system operates the hydraulic leveling motor. The pivot point of the platform is above the center line of the platform, providing a pendulum effect, reducing the energy required to level the platform. The system is electrically activated and kept level during any function of the tower. The pendulum effect of the platform will keep the platform level. This is an exclusive safety feature of this aerial.

Leveling System Override

In case of failure, there is one needle valve (1) located on the left side on the inside wall of the platform. Open this valve 1/4 of a turn and push the "emergency stop for leveling system" knob, and the hydraulic cylinder will operate with the weight in the platform, thus keeping the platform level.



Leveling System Override Valve



1.18 Optional Breathing Air System

On the aerial platform, a life support breathing system is installed. This consists of a 4500 psi, 6000 psi or 7000 psi air cylinder mounted in brackets on the turntable, a shutoff valve, and a constant flow air regulator.

Air is piped from the regulator by a heavy-duty air hose through a cable track located in the boom to the platform.

In the platform, there is an air filter, and a manifold for up to three air connections. There is a box mounted on the platform to store masks in when not in use.

Air to the mask can be regulated from the air supply cylinder by presetting the regulator at approximately 100 psi. (Refer to air mask manufacturer's recommendations). Once the air pressure regulator has been set, all that is required to provide air to the platform is to turn air on at the air cylinder valve. The air valve should always be turned off when not in use. An air drain valve is provided on the bottom of the filter and should be opened briefly and periodically to expel any moisture which may be captured in the filter. This should be done with the air system turned on. Use and care of the air system should follow departmental procedures and guidelines.

Located at the pedestal and platform are low air warning devices. They will sound an audible alarm when breathing air pressure is low. Personnel using the air should move to a nonhazardous area when the alarm sounds.

There is a silence button located on the platform control station and one located on the pedestal control station that will temporarily silence the platform alarm or the pedestal alarm. The alarm will automatically sound after two minutes, when silenced, if the air is still low.

1.19 Climbing Aerial or Using as an Escapeway

Extend or retract the aerial slightly until the RUNG ALIGNMENT LIGHT is on, indicating that the rungs of the ladder are aligned, where one section overlaps another, making it easier to climb.

When climbing the tower or when escape procedure is in progress, the UPPER POWER switches in the platform and at the turntable pedestal should be turned off, so as not to accidentally move the tower in any way.

1.20 Rappelling

Sutphen Corporation does not approve rappelling from any portion of the aerial device as we cannot control the impact loading implied upon the aerial by the sudden decelerations associated with this procedure. The lifting eyes are tie-off points for static loads associated with rescue operations.

1.21 Loading Hose

When loading hose in the main hosebed, it is helpful to raise the boom slightly.



CAUTION

Survey the area for overhead obstructions before raising the aerial.



CAUTION

Never rotate the aerial off to the side of the vehicle during this operation unless the outriggers are fully deployed.

Before raising the aerial, set the rear jacks properly to provide stability to the truck and to transfer the force of bedding the boom to the ground. To raise the boom out of the bed, use the interlock override button on the top of the pedestal and at the hydraulic control panel.



1.22 Aerial Take-Down Procedures

Stowing the Aerial Device

1. Retract aerial fully by moving the appropriate lever in the direction indicated.



CAUTION

Before retracting the aerial, make sure that the nozzle and waterway drain are open to avoid compressing any water in the waterway. Allow waterway time to drain before retracting the tower. Failure to do so can result in serious damage to the waterway. Point both nozzles down to minimize the chance of being hit during travel.

2. Rotate the aerial to the left or right until it is properly aligned and the alignment light is lighted. The aerial is now in position to lower into the support cradle.
3. Lower the aerial until it reaches the cradle, making sure the alignment light is still on before actually entering the cradle. The throttle must be at idle when actually entering the cradle area.



WARNING

Bedding the aerial at any speed other than idle may damage the vehicle.

4. After the tower is lowered into the cradle, continue to hold the control lever in the lower position a few seconds, then release the lever to permit a pilot check valve in the hydraulic circuit to trip and lock at its preset pressure. This locks the tower in the cradle for travel. This procedure works the same at either the controls at the pedestal or in the platform.
5. Turn control power switches off and exit the platform or pedestal.
6. Remove the wheel chocks.

NOTE: Always remove the wheel chocks before releasing the stabilizers. Failure to do so could result in wedging the chocks tightly against the tires making them unremovable.

7. Remove safety pins in outriggers and replace them in their holders.

NOTE: The interlock system will not allow the oil to be transferred to the jack system until both of the safety pins have been removed.

8. Retract the stabilizers-
 - A. Move to the Ground Jack Controls panel.
 - B. Turn the UPPER POWER/Hydraulic Transfer switch off.
 - C. Retract the stabilizers by starting with the front jacks reversing the setup procedure, moving from front-rear-outriggers up - outriggers in.
 - D. Replace the auxiliary outrigger pads in their holders after retracting the outriggers.
 - E. Push the operator's step in and lock in place with the locking bar.
9. Enter the cab and disengage the fire pump if used.
 - A. Shift transmission to Neutral (N).
 - B. Wait until speedometer registers 0 miles per hour.
 - C. Move pump shift lever from PUMP position to ROAD position.
10. Disengage the PTO switch from ON to OFF position. Observe that the red pilot light goes out.
11. Release parking brake.
12. Place transmission in appropriate gear [Drive (D) 1-5 or Reverse (R)].



CAUTION

Before driving away, the operator should make a quick inspection trip around the truck to make sure all tools and appliances have been removed and stowed, compartment doors are closed, and that the vehicle is unobstructed.

Operator must also check the five warning lights on the in-cab dashboard marked UPPER POWER, JACKS OUT, JACKS DOWN, CAB DOOR OPEN, and COMPARTMENT DOOR OPEN making sure they are not lighted.



WARNING

All personnel must be seated and seat belts fastened before unit is moved.



WARNING

Never back the truck unless a guide has been placed at the rear of the truck, giving clear signals to the operator. If the guide disappears from view, the movement must be stopped until the guide reappears.

▽ **Operator Manual**

1.23 Operation and Functional Description Of Pinless Aerial Jacks

Components:

Park Brake	Aerial Power Take Off (PTO)
Hydraulic Outrigger and Jack handles	Manual Override Button
Upper Power /Hydraulic Transfer Switch	Aerial Cradle Switch
LED Indicators-Lower Control Panel	Jack Interlock Solenoids
Transfer Valve	Outrigger/Jack sensors

Setup Procedure:

With the Park Brake set and the Aerial Power Take Off (PTO) engaged the Operator shall properly set the jacks to use the aerial.

To extend the Outriggers and put the Jacks down, the Operator shall open the door to the L1 compartment to access the Outrigger and Jacks hydraulic manual control handles.

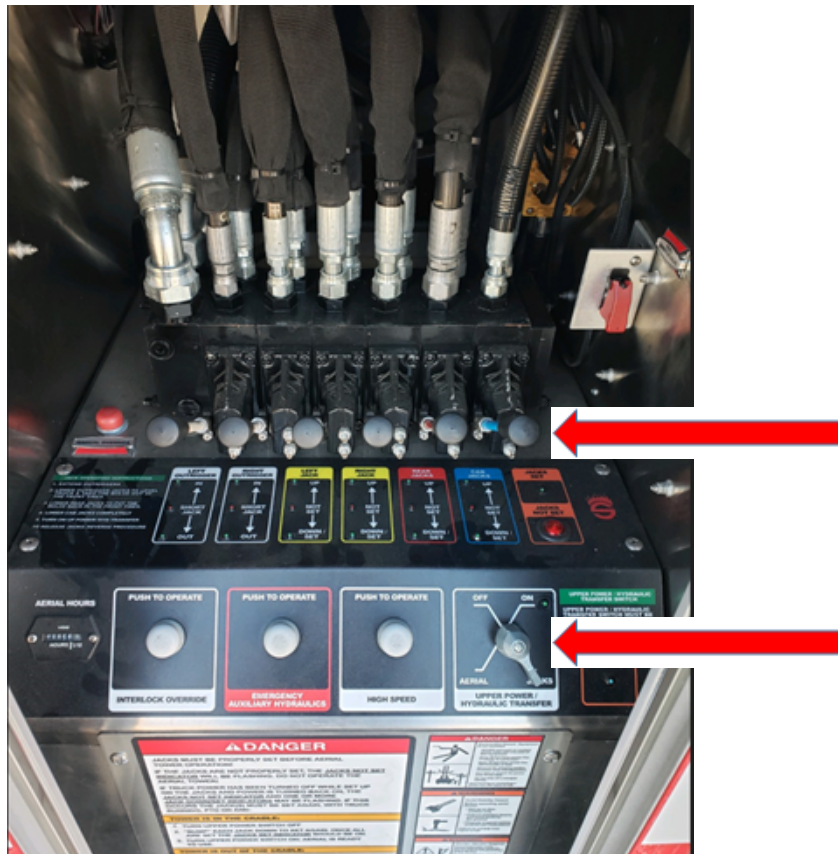



To extend the Outriggers and put the Jacks down the Upper Power /Hydraulic Transfer switch must be OFF.

With the Park Brake set and the Aerial Power Take Off (PTO) engaged:

1. Push down on the Left and Right Outrigger hydraulic handles (they can be moved individually or simultaneously) to extend the outriggers. As soon as the outriggers leave the stowed position the Jack Alarm will continue to sound until the Jacks are properly set and the Upper Power/Hydraulic Transfer switch is ON. The red Short Jack Led indicators will flash until the outriggers are fully extended. When the outriggers are fully extended the Short Jack LEDs will turn OFF and the green Out LEDs will turn ON.

Lower Control Panel:



▽ **Operator Manual**

2. Push down on the Left and Right Jack hydraulic handles (they can be moved individually or simultaneously) to put the outrigger jacks down. The red Left and Right Jack Not Set Led indicator(s) will flash until the Left and Right Outrigger Jack Down Pressure Sensors have achieved the pre-set pressure. When the Left and Right Outrigger Jack Down Pressure Sensors achieve the pre-set pressure the Left and Right Jack Down Not Set LEDs will turn OFF and the green Left and Right Jack Down/Set LEDs will turn ON indicating the jacks are down and properly set.





3. Push down on the Rear Jacks hydraulic handle to put the Rear Jacks down. The red Rear Jacks Not Set Led indicator will flash until the Rear Jacks Pressure Sensor has achieved the pre-set pressure. When the Rear Jacks Down Pressure Sensor achieves the pre-set pressure the Rear Jacks Down Not Set LED will turn OFF and the green Rear Jacks Down/Set LEDs will turn ON indicating the Rear Jacks are down and properly set.



▽ **Operator Manual**

4. Push down on the Cab Jacks hydraulic handle to put the Cab Jacks down to lock the front axle. The red Cab Jacks Not Set Led indicator will flash until the Cab Jacks Down Pressure Sensor has achieved the pre-set pressure. When the Cab Jacks Down Pressure Sensor achieves the pre-set pressure the Cab Jacks Down Not Set LED will turn OFF and the green Cab Jacks Down/Set LEDs will turn ON indicating the Cab Jacks are Down and properly set.





5. The red Jacks Not Set LED indicator on the right side of the panel will flash while moving the outriggers and/or putting the jacks down until all jacks are properly set. The green Jacks Set LED indicator will turn ON when all jacks are properly set.



▽ **Operator Manual**

6. Turn the Upper Power/Hydraulic transfer switch to the AERIAL position. The Jack Alarm will turn OFF and the green Upper Power LED indicator and the blue Jack Lockout LED indicator will turn ON. The jacks cannot be moved when the Upper Power/Hydraulic Transfer switch is ON or the Aerial Tower is out of the cradle.



7. The Aerial is now ready to fly.

Tear Down Procedure:

The Aerial Tower must be bedded in the cradle and reverse the setup procedure above:

1. Turn Upper Power/Hydraulic Transfer Switch OFF
2. Raise the Cab Jacks to the stowed position
3. Raise the Rear Jacks to the stowed position
4. Raise the Outrigger Jacks to the stowed position
5. Retract the Outriggers to the stowed position



Short Jack Procedure:

With the Park Brake set and the Aerial Power Take Off (PTO) engaged:

1. Push down on the Left and Right Outrigger hydraulic handles (they can be moved individually or simultaneously) to extend the outriggers. Short Jack means either or both outriggers are not fully extended. As soon as the outriggers leave the stowed position the Jack Alarm will continue to sound until the Jacks are properly set and the Upper Power/Hydraulic Transfer switch is ON and the Aerial Tower is out of the Cradle. The red Short Jack Led indicators will flash continuously and the green Out LEDs will remain OFF.
2. Push down on the Left and Right Jack hydraulic handles (they can be moved individually or simultaneously) to put the Outrigger Jacks down. The red Left and Right Jacks Not Set Led indicator(s) will flash until the Outrigger Jacks Down Pressure Sensors have achieved the pre-set pressure. When the Left and Right Jack Down Pressure Sensors achieve the pre-set pressure the Left and Right Jack Down Not Set LEDs will turn OFF and the green Left and Right Jack Down/Set LEDs will turn ON indicating the Jacks are down and properly set.
3. Push down on the Rear Jacks hydraulic handle to put the Rear Jacks down. The red Rear Jacks Not Set Led indicator will flash until the Rear Jacks Pressure Sensor has achieved the pre-set pressure. When the Rear Jacks Down Pressure Sensor achieves the pre-set pressure the Rear Jacks Down Not Set LED will turn OFF and the green Rear Jacks Down/Set LEDs will turn ON indicating the Rear Jacks are down and properly set.

4. Push down on the Cab Jacks hydraulic handle to put the Cab Jacks down. The red Cab Jacks Not Set Led indicator will flash until the Cab Jacks Down Pressure Sensor has achieved the pre-set pressure. When the Cab Jacks Down Pressure Sensor achieves the pre-set pressure the Cab Jacks Down Not Set LED will turn OFF and the green Cab Jacks Down/Set LEDs will turn ON indicating the Cab Jacks are Down and properly set.
5. The red Jacks Not Set LED indicator on the right side of the panel will flash while moving the outriggers and/or putting the jacks down until all jacks are properly set. The Jacks Set LED indicator will turn ON when all jacks are properly set.
6. Turn the Upper Power/Hydraulic transfer switch to the AERIAL position. The green Upper Power LED indicator and blue Jack Lockout LED will turn ON and the Jack Alarm will continue to sound until the Aerial Tower is out of the cradle because one or both outriggers is short jacked. The jacks cannot be moved when the Upper Power/Hydraulic Transfer switch is ON or the Aerial Tower is out of the cradle.
7. The Aerial is now ready to fly.



If Truck Power Has Been Turned Off While Set Up On The Jacks:

If truck power has been turned off or power is lost while set up on the jacks it may be necessary to reset the jacks when power is turned back on. If this occurs the Jacks Set Led will be flashing and one or more Jack Down Set Led indicators may be flashing.

To reset, the Park Brake must be set and the Aerial Power Take Off (PTO) engaged and if the Aerial Tower is in the Cradle:

1. Turn Upper Power/Hydraulic Transfer Switch OFF. The Jack Alarm will sound.
2. Push down on the Left and Right Jack hydraulic handles (they can be moved individually or simultaneously) to put the Outrigger Jacks down. The red Left and Right Jack Not Set Led indicator(s) will flash until the Jack Down Pressure Sensor(s) have achieved the pre-set pressure. When the Left and Right Jack Down Pressure Sensors achieves the pre-set pressure the Left and Right Jack Down Not Set LEDs will turn OFF and the green Left and Right Jack Down/Set LEDs will turn ON indicating the Jacks are down and properly set.
3. Push down on the Rear Jacks hydraulic handle to put the Rear Jacks down. The red Rear Jacks Not Set Led indicator will flash until the Rear Jacks Down Pressure Sensor has achieved the pre-set pressure. When the Rear Jack Down Pressure Sensor achieves the pre-set pressure the Rear Jacks Down Not Set LED will turn OFF and the green Rear Jacks Down/Set LEDs will turn ON indicating the Rear Jacks are down and properly set.
4. Push down on the Cab Jack hydraulic handle to put the Cab Jacks down. The red Cab Jacks Not Set Led indicator will flash until the Cab Jacks Down Pressure Sensor has achieved the pre-set pressure. When the Cab Jacks Down Pressure Sensor achieves the pre-set pressure the Cab Jacks Down Not Set LED will turn OFF and the green Cab Jacks Down/Set LEDs will turn ON indicating the Cab Jacks are Down and properly set.
5. The red Jacks Not Set LED indicator on the right side of the panel will flash while moving the outriggers and/or putting the jacks down until all jacks are properly set. The green Jacks Set LED indicator will turn ON when all jacks are properly set.
6. Turn the Upper Power/Hydraulic transfer switch to the AERIAL position. The Jack Alarm will turn OFF and the green Upper Power LED indicator and blue Jack Lockout LED indicator will turn ON.
7. The Aerial is now ready to fly.

Operator Manual

Jack Down Pressure Sensor:

To reset any Jack Down pressure Sensor, the Park Brake must be set and the Aerial Power Take Off (PTO) engaged. If the Aerial Tower is out of the Cradle:

1. Turn Upper Power/Hydraulic Transfer Switch OFF. The Jack Alarm will sound.
2. Press the Manual Override button on the left side of the control panel.

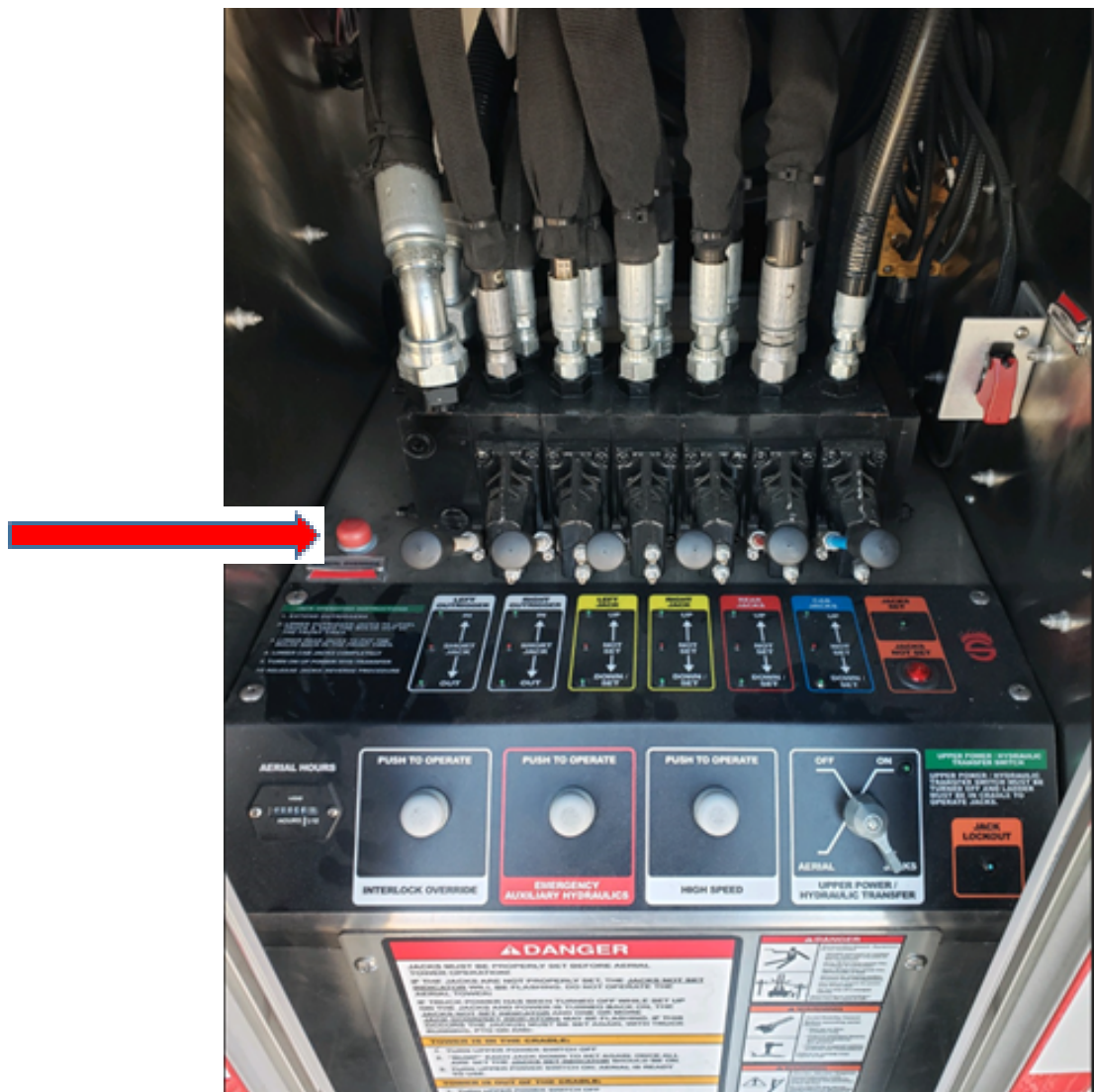



3. Push down on the Left and Right Jack hydraulic handles (they can be moved individually or simultaneously) to put the Outrigger Jacks down. The Left and Right Jack red Not Set Led indicator(s) will flash until the Left and Right Jack Down Pressure Sensor(s) have achieved the pre-set pressure. When the Left and Right Jack Down Pressure Sensor(s) achieves the pre-set pressure the Left and Right Jack Down Not Set LEDs will turn OFF and the green Left and Right Jack Down/Set LEDs will turn ON indicating the Jacks are down and properly set.
4. Push down on the Rear Jack hydraulic handle to put the Rear Jacks down. The red Rear Jacks Not Set Led indicator will flash until the Rear Jacks Down Pressure Sensor has achieved the pre-set pressure. When the Rear Jack Down Pressure Sensor achieves the pre-set pressure the Rear Jacks Down Not Set LED will turn OFF and the green Rear Jacks Down/Set LEDs will turn ON indicating the Rear Jacks are down and properly set.
5. Push down on the Cab Jack hydraulic handle to put the Cab Jacks down. The red Cab Jacks Not Set Led indicator will flash until the Cab Jacks Down Pressure Sensor has achieved the pre-set pressure. When the Cab Jacks Down Pressure Sensor achieves the pre-set pressure the Cab Jacks Down Not Set LED will turn OFF and the green Cab Jacks Down/Set LEDs will turn ON indicating the Cab Jacks are Down and properly set.
6. The red Jacks Not Set LED indicator on the right side of the panel will flash while moving the outriggers and/or putting the jacks down until all jacks are properly set. The Jacks Set LED indicator will turn ON when all jacks are properly set.
7. Release the Manual Override Button.
8. Turn the Upper Power/Hydraulic transfer switch to the AERIAL position. The Jack Alarm will turn OFF and green Upper Power LED indicator and the Jack Lockout LED indicator will turn ON.
9. The Aerial is now ready to fly.

Functional Description

Components:

Park Brake	Aerial Power Take Off (PTO)
Hydraulic Outrigger and Jack handles /functions	Manual Override Button
Upper Power /Hydraulic Transfer Switch	Aerial Cradle Switch
LED Indicators-Lower Control Panel	Jack Interlock Solenoids
Transfer Valve	Outrigger/Jack sensors

Park Brake:

The Park Brake is located in the cab and sets the air brakes to prevent rolling or unintended movement of the truck while stationary. The Park Brake signal is used in interlock functions for safety. It is also used for activation of specific circuits.

Aerial Power Take Off:

The Aerial PTO is activated by the Operator by a switch or button. The Aerial PTO can only be activated if the Park Brake is set and all other interlock functions related to the Aerial PTO are satisfied such as low engine RPM for engagement and transmission interlocks.

Hydraulic Outrigger and Jack Handles/Functions:

The Hydraulic handles provide a manual means for the Operator to extend and retract the outriggers and jacks. There are two outriggers, Left and Right and there are six Jacks with one for each outrigger and a pair at the rear of the truck (Rear Jacks) and a pair at the front of the truck that lock down the front axle (Cab Jacks). The outriggers and jacks are used to stabilize the truck to allow aerial operation.



Upper Power/Hydraulic Transfer Switch:

The Upper Power/Hydraulic Transfer Switch (UPHTS) is used to turn on 12VDC Upper Power to certain devices on the aerial and to transfer hydraulic fluid from Jack operation to Aerial operation. The UPHTS switch signal is also used in interlock functions for safety.

LED Indicators:

The LED indicators on the Lower Control Panel are used to inform the operator of the Outriggers/Jacks status conditions.

Manual Override Button:

The Manual Override Button (MOB) is a signal used in interlock functions for safety. It is used only when the truck is set up on the jacks and power has been cycled (Ignition) and the aerial is out of the cradle and the Jacks Not Set LED is flashing. The MOB is used to help reset the Jacks that are indicating they are no longer set.

Transfer Valve:

Transfer Valve (TV) is used to direct hydraulic fluid either to the Outriggers/Jacks or Aerial operation. The TV has a common fluid gallery with two exit ports controlled with solenoid valves, one for the Outriggers/Jacks and one for Aerial operation.

The solenoid for the Outriggers/Jacks is a Normally Closed (NC) valve and must be energized to allow Outrigger/Jack function. The power for the NC valve is controlled by safety interlocks.

The solenoid for aerial operation is Normally Open (NO) valve and must be deenergized for aerial operation. This allows aerial operation in the event of electrical failure. The power for the NO valve is controlled by safety interlocks.

Aerial Cradle Switch:

The Aerial Cradle Switch is used to indicate when the Aerial Tower is bedded in the cradle or out of the cradle. The signal is used in interlock functions for safety and Operator LED indicators.

Outrigger/Jack Sensors:

The outriggers each have a sensor located inside the outrigger tube that senses when the outrigger is short jacks or fully extended and is used in conjunction with a second sensor indicating the outrigger is fully stowed. Both sensors' signals are used in interlock functions for safety.

The outrigger jacks each have a Jack Stowed Sensor and a Jack Down Pressure Sensor. The Jack Stowed Sensor detects when the jack is stowed and is used in interlock functions for safety. The Jack Down Pressure Sensor detects when the jack is in contact with the ground and has lifted the truck enough to reach the pressure setpoint indicating the jack is down.

The Rear Jacks have a Jack Stowed Sensor and a Jacks Down Pressure Sensor. The Jack Stowed Sensor detects when the jack is stowed and is used in interlock functions for safety. The Jack Down Pressure

Sensor detects when the jacks are in contact with the ground and have lifted the truck enough to reach the pressure setpoint indicating the jacks are down.

The Cab Jacks have a Jack Stowed Sensor and a Jacks Down Pressure Sensor. The Jack Stowed Sensor detects when the jack is stowed and is used in interlock functions for safety. The Jack Down Pressure Sensor detects when the jacks are in contact with the front axle and have lifted the truck enough to reach the pressure setpoint indicating the jacks are down.

The Jack Interlock Solenoids are installed on the UP hose for the Outrigger Jacks and the Rear Jacks to prevent the jacks from moving up while the Tower is out of the cradle and resetting pressure on the jacks.

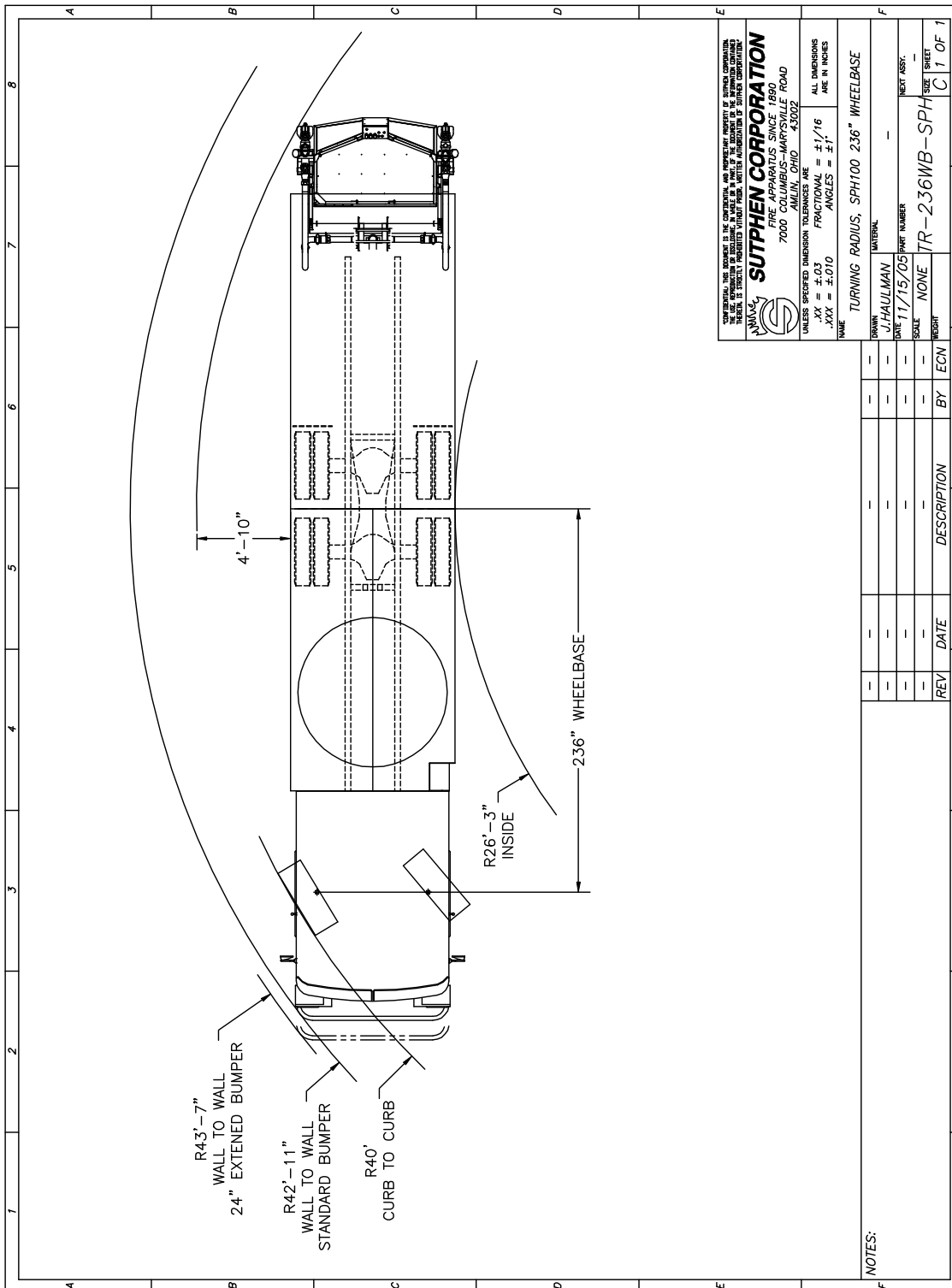

UNLESS SPECIFIED DIMENSION TOLERANCES ARE:
 .XX = ±.03 FRACTIONAL = ±1/16 ALL DIMENSIONS ARE IN INCHES
 .XXX = ±0.010 ANGLES = ±1/2°

SUTPHEN CORPORATION
 FIRE APPARATUS SINCE 1860.
 7000 COLUMBUS-MARYSVILLE ROAD
 ARLIN, OHIO 43002

NAME: TURNING RADIUS, SPH100 236" WHEELBASE
 DRAWN: J. HAULMAN
 DATE: 11/15/05
 SCALE: NONE
 PART NUMBER: TR-236WB-SPH
 SHEET: C 1 OF 1

NOTES:

REV	DATE	DESCRIPTION	BY	ECN
1				
2				
3				
4				
5				
6				

▽ **Operator Manual**

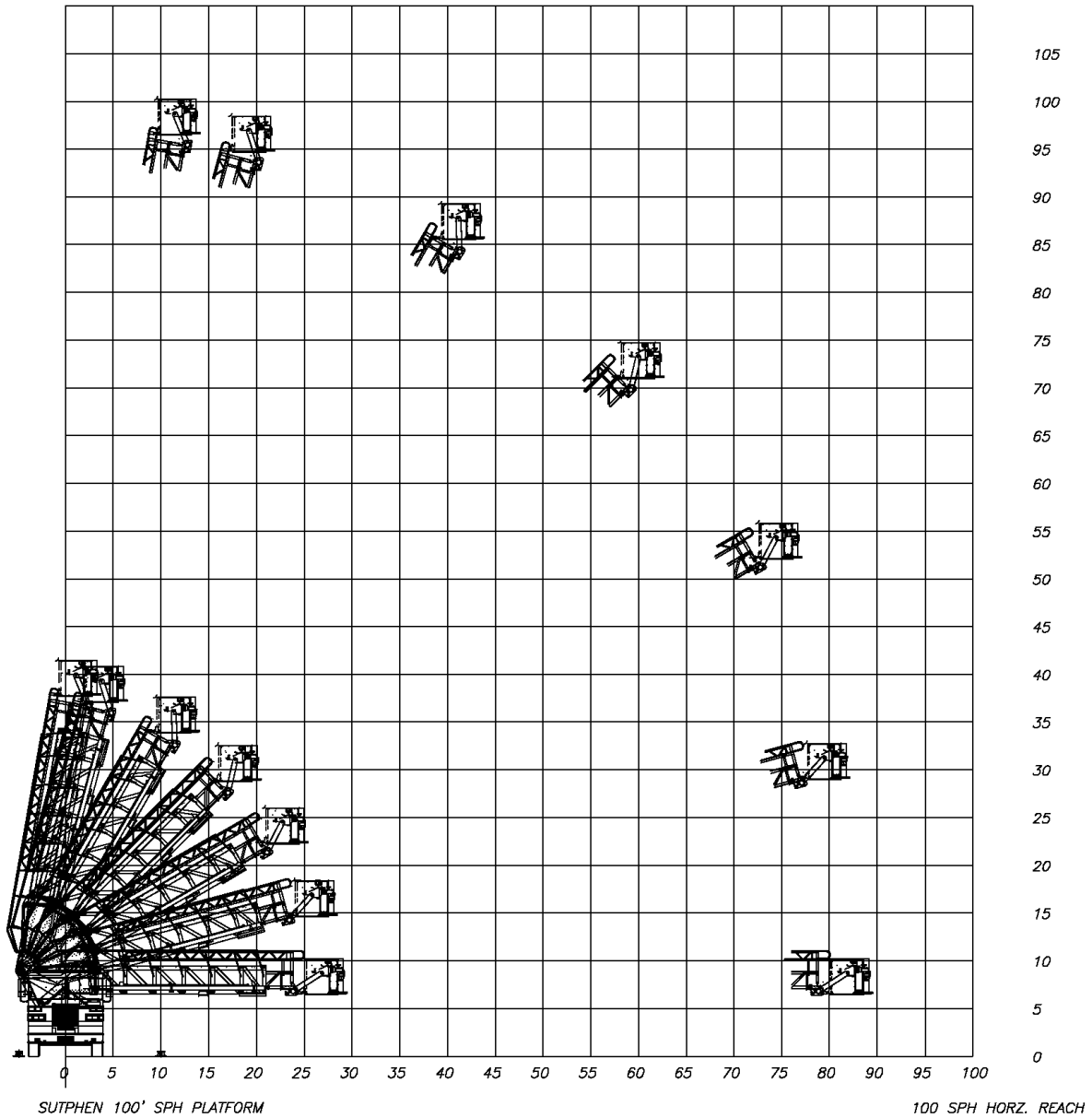



Chapter 2 Maintenance Manual

	<u>Page</u>
2.1 Aerial Maintenance	2-3
<i>Outrigger Beams</i>	2-3
<i>Main Lift Cylinders</i>	2-3
<i>Pivot Shaft Bearings</i>	2-3
<i>Turntable Bearing</i>	2-3
<i>Fairfield Drive</i>	2-4
<i>Aerial Extension/Retraction Cylinders</i>	2-5
<i>Sheaves, Cables, and Lacings</i>	2-5
<i>Cable Adjustment</i>	2-6
Before Extending Aerial	2-6
<i>Slide Block</i>	2-19
Lubrication	2-19
Description	2-19
Daily Preventative Maintenance (PM)	2-20
Before Beginning	2-20
Standard Operating Procedure	2-21
Periodic Preventative Maintenance (PM)	2-23
<i>Cable Track</i>	2-24
Maintenance	2-24
<i>Waterway and Seals</i>	2-26
<i>Torque-Hub® Planetary Final Drive ATC8300</i>	
<i>Counterbalance Valve</i>	2-27



Maintenance Manual

	Assembly	2-27
	<i>Hydraulic Oil Tank</i>	2-29
	<i>Hydraulic Oil Tank Fill Procedure</i>	2-30
	<i>SPH 100 Fitted with KFS 4447 Reservoir Assembly</i>	2-31
	<i>Fuel Tank</i>	2-33
2.2	Maintenance of Structure	2-34
	<i>Aluminum Tower Structure</i>	2-34
	<i>Attachment of Support Structure to Truck Frame</i>	2-34
	<i>Chassis Maintenance</i>	2-34
2.3	Aerial Tower Lubrication Requirements	2-35
2.4	Torque Values for Various Fasteners.....	2-37
	Daily/Weekly Walk-Around Check for Mobile Fire Apparatus	



2.1 Aerial Maintenance

Outrigger Beams

Ride on plastic guides - No lubrication required.

Main Lift Cylinders

Composite bushings - No lubrication required.

NOTE: There are four setscrews used as locking pins to secure the rod eye to the ram cylinder. These setscrews should be checked and re-tightened at this time.

Pivot Shaft Bearings

Located on the top of the upper assembly side plates are two pivot shaft bearings, one on each side, which rotate on the pivot shaft. The pivot shaft is attached permanently to the turntable side plates on the outside of the side plates. There are grease fittings installed on the pivot shaft bearings. These bearings should be lubricated with a number 2 grade multipurpose grease every 25 hours of operation.

Turntable Bearing

This bearing and drive gear assembly is located directly under the turntable. The entire turntable and tower assembly rotates on this bearing. This bearing is pre-lubricated at the factory with the approved lubrication/grease. Two grease fittings are provided on the top of the bearing accessible through the turntable openings, one each side of the turntable. Lubrication should be done once per year. Use the approved lubrication/grease. To grease the bearing, have one person apply the grease while another rotates the aerial one revolution or 360 degrees.

NOTE: At this time, we recommend that all the bolts attaching the turntable to the bearing, and all the bolts attaching the bearing to the turntable base should be checked for tightness. They should be checked at 250 ft lb of torque.



DANGER

The person operating the turntable for bolt alignment must make sure that all persons and tools are free and clear before rotating.

The drive pinion gear and the turntable bearing gear have been lubricated with a special permanent elastic lubricant designed to last the life of the unit.

Fairfield Drive

The turntable is equipped with a rotating mechanism consisting of two hydraulically powered, planetary gear boxes (Fairfield Drives) that provide rotation for the boom. The power operated turntable provides continuous rotating of the aerial structure clockwise or counter clockwise, thus enabling the boom to be positioned in any segment through 360 degrees. The rotating mechanism also provides sufficient power to rotate the aerial sections in any direction at any angle, fully extended, while carrying the rated load capacity with the waterway in operation and discharging water at the tip of the aerial fly section.

A brake system is incorporated into the Fairfield drives and is capable of holding the turntable in a stationary position regardless of the angle or extension of the aerial, while carrying the rated load capacity with the waterway in operation and discharging water at the tip of the aerial fly section.

In the event of a loss of engine power, emergency operation of the rotation system is possible through an auxiliary power unit that is capable of providing hydraulic power to safely rotate the aerial. It is necessary to release the parking brake when operating with the emergency auxiliary power unit and the manual handles at the pedestal.

Maintenance of the Fairfield Drive, will include an initial oil change after the first 50 hours of operation and every 500 hours there after or annually, whichever comes first. Fill the oil to the middle of the topmost gear, with 32 ounces of 80w90 gear oil.



Aerial Extension / Retraction Cylinders

Located on each side of the first tower section is a cylinder which extends and retracts the tower assembly. There is only one point on the cylinder which requires lubrication; this being at the rod end eye mounting pin. A grease fitting is provided on the rod eye of the cylinder and should be lubricated two times per year. Use multipurpose grease. At each end of the cylinder there are bolts attaching the cylinder pin to the tower. These bolts should be checked every (3) three months for tightness.

Sheaves

There are sheaves and cables which are part of the tower extension/retraction system from the second section on up. The sheaves are greaseless composite bearings that require no lubrication.

If you see a distinct, irremovable black ring around any of the sheaves, contact your local certified Sutphen service center because the sheave may need to be replaced.

Cables

When servicing the cables, the tower should be extended horizontally to maximum position, and the cables wiped free of any dirt and/or grime with a slightly moist naphtha cloth and then lubricated with a thin film of Chain Mate.

Lacings

Located on the boom of the aerial, lacings are supports that can be connected to the long structural angles of the boom by bolts and/or huck bolts. 1/4" - 3/8" bolted connections on the lacings are to be torqued to 5 ft-lbs with a lock nut. For huck bolts connections- re-torquing is not required.

Any indication of huck bolts loosening or any bolt failure should be reported to Sutphen Corporation for evaluation and disposition.

Cable Adjustment

Before Extending Aerial

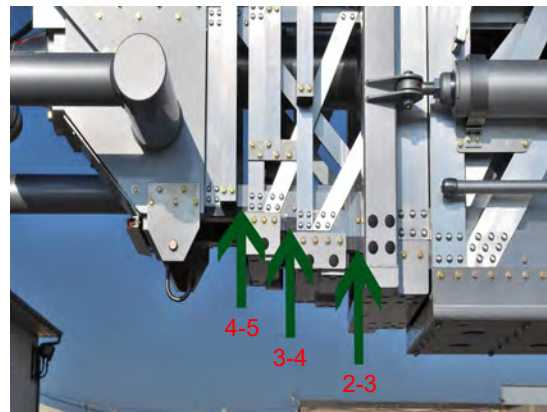

First to Second
Sections
Fixed with
Cylinders

Fourth to Fifth
Sections,
Third to Fourth
Sections, Second to
Third Sections

Ladder Sections Gap

1. Check clearance between ladder sections two through five.
2. Gaps should be 1/4 inch minimum, up to 1 inch maximum.

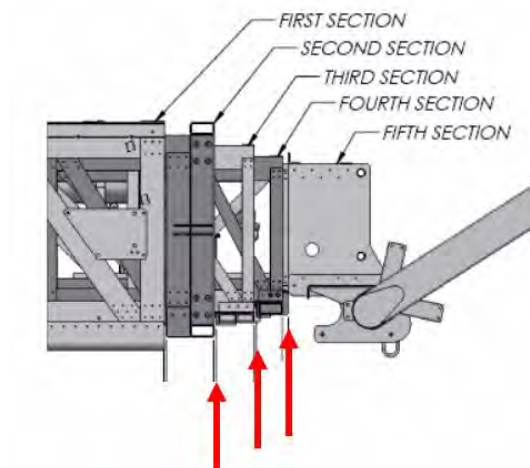

Fully Retracted Ladder Section Spacing

3. Check ladder sections spacing. Ladder sections should never be touching when in horizontal position. If they do touch, they need to be adjusted (sections pulled apart) as outlined in the steps that follow.

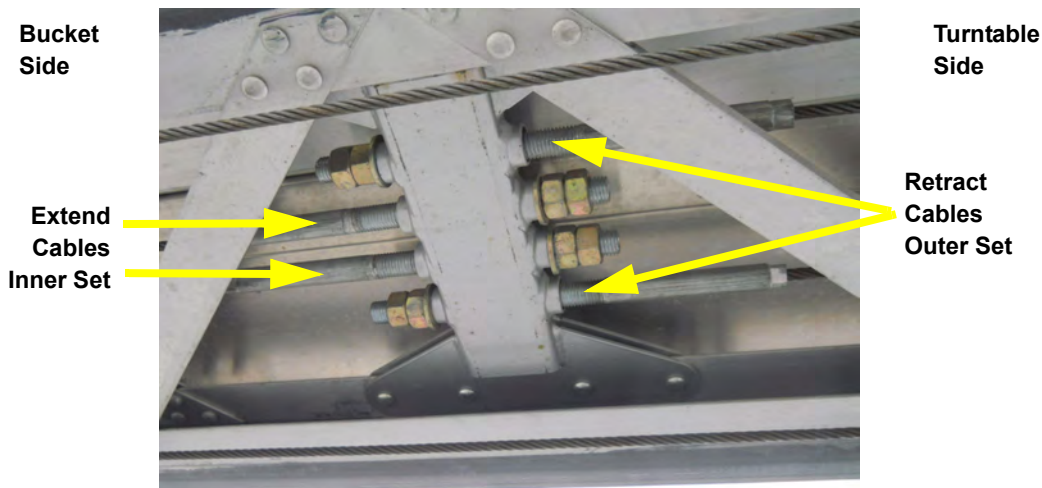

Extension and Retraction Cables Loosening Points

4. Set up aerial device according to the operator's manual.
 - a. Rotate ladder over the side of the apparatus and position the aerial so the cables can be reached from the ground.
 - b. Make sure waterway is empty and there is no extra weight in the platform.
5. With aerial fully retracted, make sure there is a minimum of 1/4 inch and a maximum of 1 inch of gap between all ladder sections. If you do not have the required spacing, make adjustments before proceeding.

NOTE: The gap between ladder sections one and two is set by the cylinder connection. This should be set at the factory and never needs to be adjusted.

6. To adjust the gaps between the other sections, fully extend the ladder and measure the distance between the sections. It should be a minimum of 179-1/4 inches.

▼ **Maintenance Manual**

7. If gap is less than the minimum:
 - a. Loosen the retract cables.
 - b. Retract the ladder approximately 24 inches until the arrows align.
 - c. Tighten the extend cables.
 - d. Repeat this process as necessary to achieve the 179-1/4 inch-minimum on all sections.
 - e. Fully retract the ladder and the spacing between the sections. Once the minimum spacing is achieved, proceed with the adjustment procedure.



Ladder Fully Extended

8. Fully extend ladder out.

NOTE: Ladder rails and waterway must be clean and properly lubricated with recommended lubrication for this aerial model before proceeding with cable adjustment.

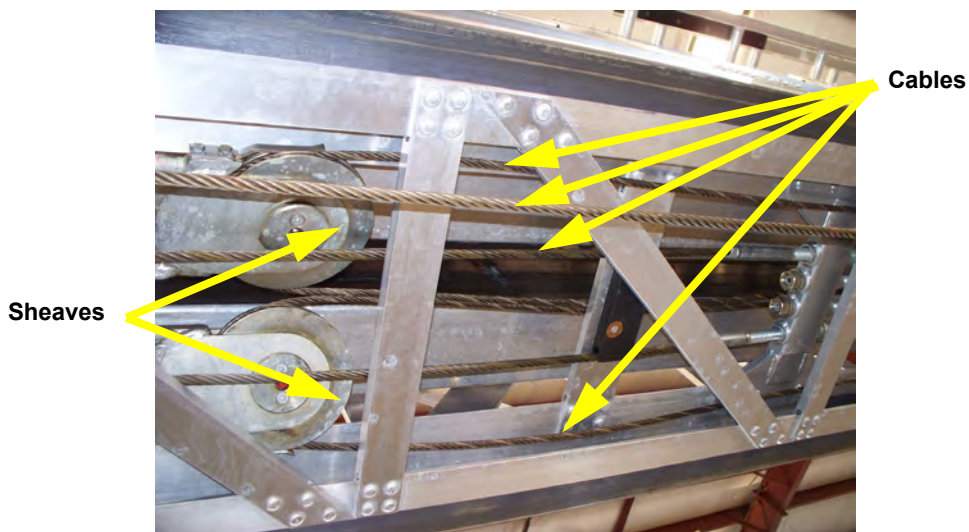

Cables and Sheaves

9. Inspect cables to ensure no kinks, damage, or fraying is present and inspect sheaves to ensure there is no visible damage.



Ladder Sections One and Two - 24 Inch Mark Point

10. Measure 24 inches from end of first ladder section to second ladder section and mark the spot.



Ladder Retracted to Marked Point

- 11.** Retract ladder in 24 inches until it is positioned exactly at the mark.

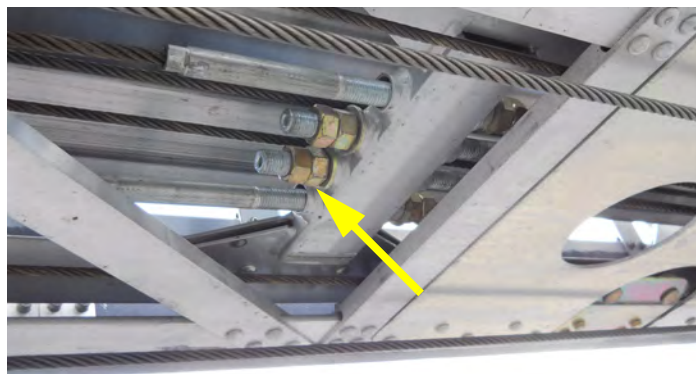

Cable Beam and Extend Cables Adjustment Points

NOTE: Retracted ladder position should now allow access to extend cables adjusting hardware.



Measuring Point for Other Ladder Sections



Close Up of Measuring Point

12. Measure remaining distance on ladder sections two, three, and four.

▼ **Maintenance Manual**



Center of Ladder Section Mark

13. Take half of the measurement taken previously and mark the center of the ladder sections two, three, and four.

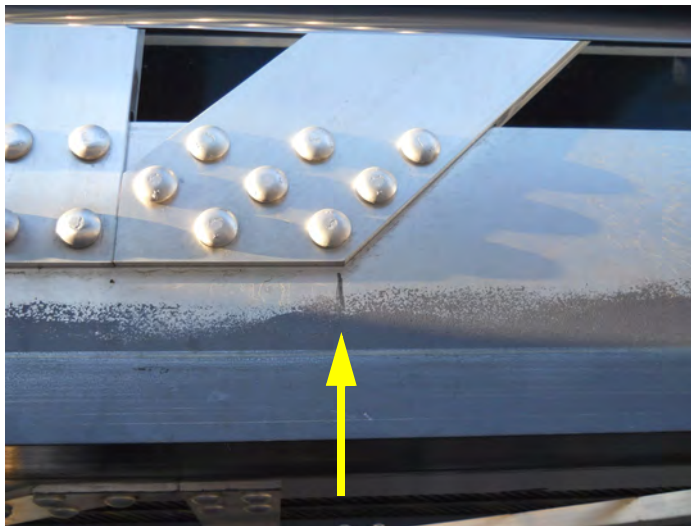

Mark for Measurement Position for each Section

NOTE: Each ladder section should be marked at the point where the measurement should be taken (sample shown above).



Measurement Areas Between Ladder Rail and Cable

14. At the mark at the midpoint (shown at red arrow), measure down to the cable. Measurement must be $1\text{-}1/4$ + $1/4$ inch tolerance if needed (maximum $1\text{-}1/2$ inch) from bottom of ladder rail to top of cable.

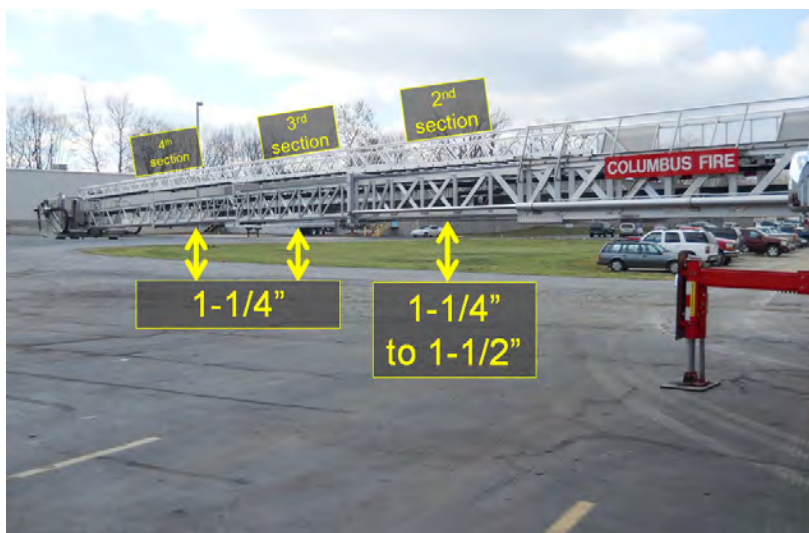

Bottom of Ladder Rail/Top of Cable Measurement Specifications

NOTE: Ladder sections and applicable measurements shown above. Measurements are taken from the center of sections two, three, and four down to the cable.



NOTE: 2" arrows indicate the maximum length the droop can be.

If droop exceeds 2" maximum the truck is to be taken out of service until adjustments are made.



Cable Adjustment

15. Adjust cables as needed to achieve applicable measurements specified in previous steps:

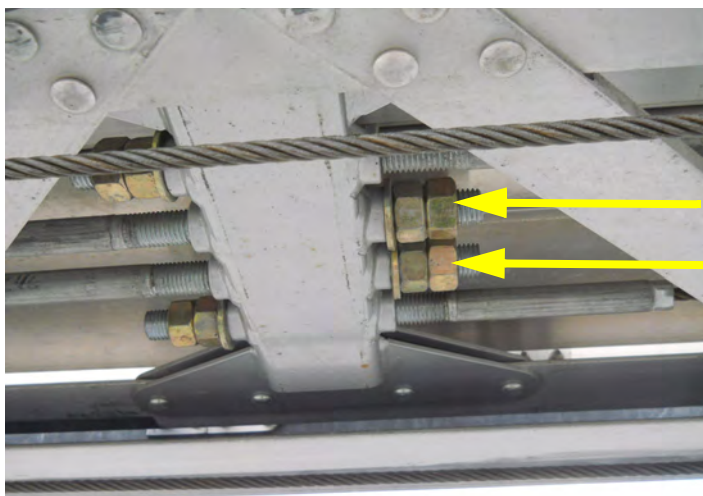

Cable Loosening Points

- a. Loosen outer jam nuts.



Threaded Rod



Adjustment Nut and Jam Nut Tightening

- b.** Tighten inner adjustment nut while holding steady the base of the threaded rod (close up shown in upper graphic) in order to prevent the cable from turning and possibly causing cable damage or unraveling.



Cables Adjustment - Outer Jam Nut Retighten

c. After cable adjustments are completed, retighten outer jam nuts.

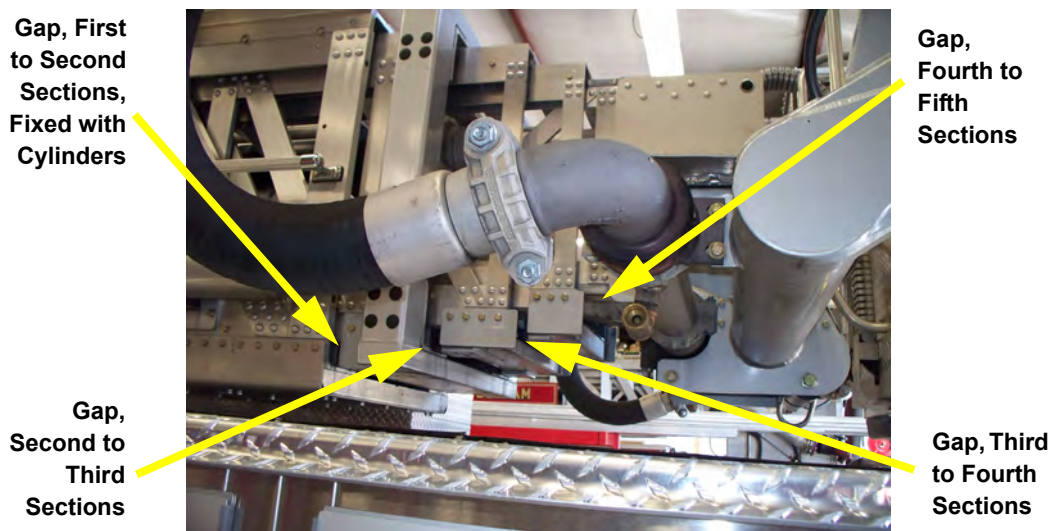

Final Ladder Section Gap Check

NOTE: All adjustments are made at the horizontal position. Ladder sections may touch at vertical retraction.

16. Fully retract the ladder and perform the final check of the ladder section gaps:
 - a. Measure clearance between ladder sections, sections two through four.

▼ **Maintenance Manual**



Ladder Gap Measuring Point - Fourth and Fifth Sections

- b.** Measure clearance between ladder sections four and five.



DANGER

Stabilizers must be set before performing this operation.



DANGER

If any strand of the cable is fractured or damaged, immediately lower the aerial and retract slowly. Remove from service until repaired.

Slide Block

Lubrication

Bill of Materials 	Required Tools
Sutphen recommends: ProOne EP-2 Grease For more information, see the email or website below: Email: info@pro-one.us www.pro1energy.com To purchase ProOne EP-2 Grease, email below: Email: Sales@GlobalGreenLubricants.com	Painters brush or foam brush Extended pole for the brush
Sutphen does not recommend: Use of red tacky grease as the compounds will cause the ladder to not function properly.	Extended pole for the brush

Description

Slide Blocks are the devices attached to the ends of the tower at both the upper, lower and side positions on each section. They support each section of the tower, so that metal-to metal contact cannot occur.

The material is a UHMW polymer compound and is designed to withstand heavy loads. Lubrication is required in the path in which the slide blocks travel on each section. The slide block paths on the aerial have been coated with a translucent white ProOne grease (see Bill of Materials above). It is available in convenient 400 gram Cartridges.

Daily Preventative Maintenance (PM)

It is important to review the aerial slide pads and path on each section. Foreign material may become lodged between the ladder sections and the slide pads. This inevitably could cause damage to the tower. Sutphen recommends reviewing the slide pads and slide area every 25 hours of aerial use. Make sure that the sliding area has a thin coating of grease along all of the slide path areas.

NOTE: Within the work instruction below, you will note key quality and safety points identified with either a "Q" or an "S". Pay special attention to these items in detail for safe and quality results.

Before Beginning



WARNING

Stabilizers must be set before performing this operation. Failure to set stabilizers before performing this procedure could result in severe injury or death.

In order to properly lubricate the tower, extend the tower to the side of the truck and lower the boom so you can reach all sides of the aerial device.







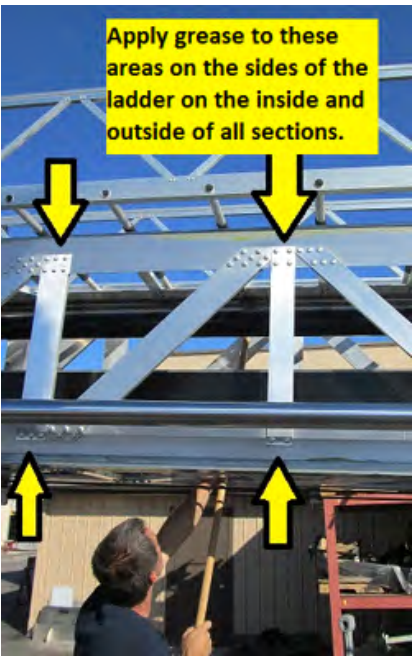

Standard Operating Procedure

Step No.	Q/S	Process Step Description	Associated Picture and/or Key Details
1	<p>Q</p> <p>Q</p>	<p>Using a brush:</p> <p>Apply a liberal amount of grease in the area above and below where the vertical lacings come in contact with the long structural angles of the boom.</p> <p>Apply grease on the interior, exterior, and sides of the aerial.</p> <p>NOTE: In order to reach some of the areas within the boom, an extended pole might be needed.</p>	

Note: As the boom is extended and retracted, the grease will build up in the grease pockets of the slide blocks and distribute across the angle sections as shown.

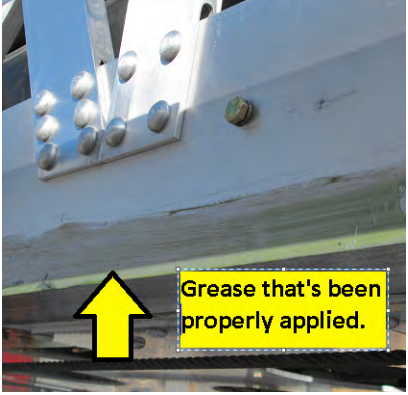

▼ **Maintenance Manual**

<p>2</p>	<p>S</p>	<p>Once all areas are properly lubricated, raise the ladder while it is fully extended to 70 degrees.</p> <p> CAUTION Be aware of all surroundings while lifting/ extending the boom assembly.</p> <p>Once the boom is raised, extend and retract the boom 5 to 6 times while at 70 degrees.</p> <p>This step will apply grease to the entire length of the aerial.</p>	
<p>3</p>	<p>Q</p> <p>Q</p> <p>Q</p>	<p>Next, bring the aerial back to the position in which it was while originally applying grease, extended off to the side of the truck.</p> <p>Review all slide block paths to make sure the grease is applied evenly.</p> <p>A correctly greased ladder section should resemble the one shown to the right.</p> <p>If you find areas where grease is missing or the slide path appears dry, apply additional product to that area.</p>	 <p>Grease that's been properly applied.</p>  <p>Slide path that requires additional grease.</p>



Periodic Preventative Maintenance (PM)

Periodically, the ladder will need to be steamed-cleaned or pressure-washed to remove the grease material and then new product applied. Depending on the aerial usage hours, operating conditions and age of the existing grease, and the amount of time between thorough cleanings, will vary. A clean film of grease is always the best application for the aerial, so if any area becomes contaminated with debris, metal shavings, etc., it is recommended that you again remove the existing product and apply new.

There are exceptions to this schedule that should be considered. Should the tower be operated at a fire and exposed to excessive dirt and grime, we recommend that the slide block travel paths be cleaned and the tower be coated. A medium film of ProOne grease in the path of the slide block travel is adequate.

Do not clean your aerial using any cleaning agents or solvents that can cause chemical degradation to plastic slide blocks or other parts made from the same UHMW material.

Cleaning agents or solvents containing the following chemicals should not be used: chlorine, benzene, toluene or any compound with a Ph over 10 (i.e., sodium hydroxide).

Use of agents containing the above chemical will void your warranty due to the fact that it may cause surface cracking of the UHMW plastic material.

Cable Track

The cable track should be inspected, maintained and cleaned after each use.

Maintenance

- The cable track assembly used on aerial ladders consists of the cable track containing the cables in the boom for electrical controls and the supporting cable troughs. Both the cable track and the cable troughs must be cleaned on a regular basis to maintain proper functionality. Cleaning must be done at least annually, or sooner, if debris is found in the cable track or troughs.
- Inspect the cable track and troughs for debris after the aerial has been used on scene during fire fighting, or if it is suspected debris may have fallen into the ladder from trees or other objects while driving. Otherwise, it is recommended to inspect after 25 hours of operation.
- To clean the cable track assembly, the vehicle must be set up for aerial operation to facilitate cleaning. Refer to this operator and maintenance manual for the proper procedure for setting the jacks and operating the aerial.
- Once the jacks are set, position the ladder over one side with the ladder fully extended and the platform touching the ground.
- Check for debris and remove any if found.
- Do not use solvents or detergents of any kind to clean the cable track or troughs. Clean the cable track and troughs with water using a hose no larger than 1-inch diameter and do not use more than 100 psi.
- After cleaning the cable track and troughs with water, use compressed air to remove residual water and blow out any remaining debris or dust.



- The picture above shows a cable trough that has been properly cleaned and lubricated with dry film lubrication.
- When finished cleaning, inspect the cable track for any damage or doors that may be loose or missing. Make sure all cable track doors are securely locked in place before retracting the ladder.

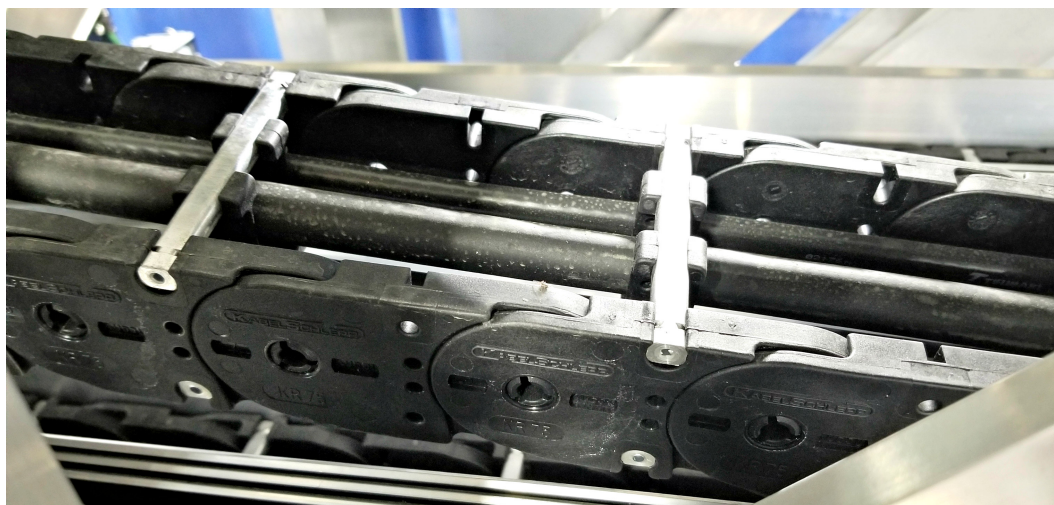

- The picture above shows the cable track with doors intact and properly locked in place.
- The ladder is now ready to be retracted, stowed, and returned to service.

Waterway and Seals

This is the telescopic tube device inside the tower that carries the water to the tower nozzle. It has seals which ride on the internal honed and hard-coated surface of the tubes. These seals are made with an impregnated lubricant and should be adequately self-lubricated and cleaned by the water that passes through the waterway. However, it will prolong the life of your waterway if it is wiped off periodically with a rag saturated with ATF Dex Merc. If it looks dry - Lubricate.

The outside of the tubes are provided with nylon bearing collar assemblies built in the mounting collar of each section. The outside of the tubes should be kept wiped free of dirt and grime to protect the bearings. Should the aerial be used under extremely dirty conditions, the waterway should be wiped off before retracting to keep dirt from entering the bearings. The ladder is best accessed with it fully extended and lowered over one of the outriggers.

Consistent cleaning of the tower travel paths is the best and most inexpensive maintenance you can perform to keep the tower in perfect operation condition.



Torque-Hub® Planetary Final Drive ATC8300 Counterbalance Valve

Assembly

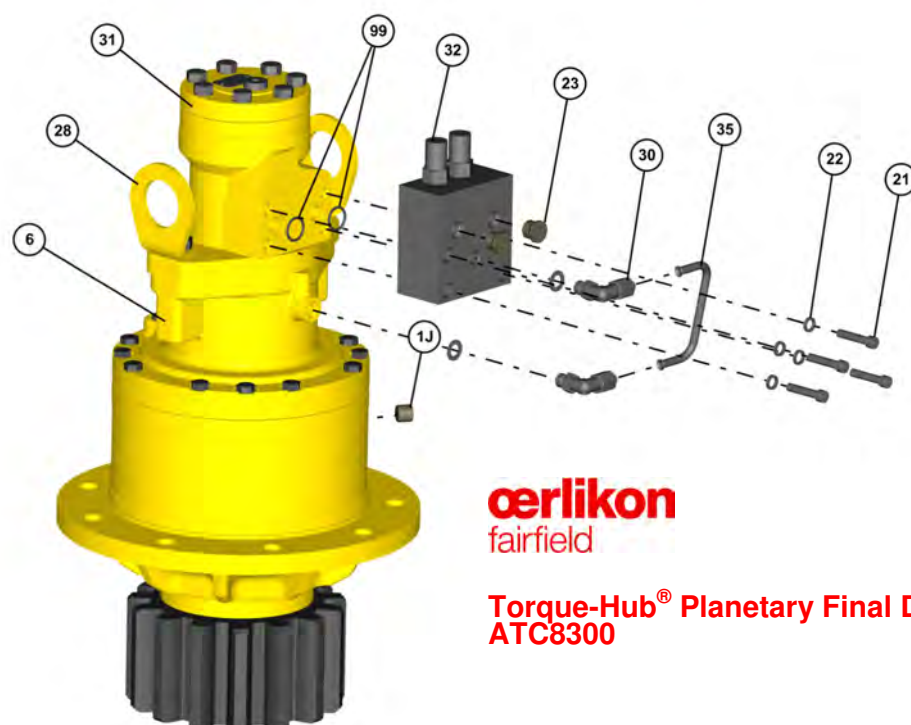

erlikon
fairfield

**Torque-Hub® Planetary Final Drive
ATC8300**

Callout	Qty	Description
1J	2	Pipe Plug
6	1	Brake Housing
21	4	Bolts
22	4	Lock Washer
23	2	O-Ring/Pipe Plug
28	2	Lift Lug
30	3	Elbow
31	1	Hydraulic Motor
32	1	Counterbalance Valve
35	1	Hydraulic Tube Assembly
99	2	O-Rings (940001)

 **Maintenance Manual**

1. Lay assembly down with motor ports facing up. Install o-rings (99) into counter bore on motor valve face.
2. Assemble the counterbalance valve (32) onto the hydraulic motor (31) with four bolts (21) and lock washers (22). Tighten bolts (21) to 18 to 20 ft/lb.

NOTE: Be sure to align the holes in the counterbalance valve with the motor ports.

3. Install elbow fitting (30) into brake housing (6). Do not tighten jam nuts.
4. Install elbow fitting (30) into counterbalance valve (32). Ensure orientation is correct. Do not tighten jam nuts.
5. Assemble hydraulic tube assembly (35) into elbow fittings (30) and tighten to 13 to 15 ft/lb. Tighten the jam-nuts on both elbow fittings (30) to 13 to 15 ft/lb.
6. Install one o-ring plug (23) into counterbalance valve (32) and tighten to 18 to 20 ft/lb.
7. Pressure test brake, tube, and control valve connections by applying 3000 psi pressure to the open port in the counterbalance valve (32) and holding for one minute. Check for leaks at the control-valve-motor interface and the tube connections. Release pressure and install the remaining o-ring plug (23) into counterbalance valve (32) and tighten to 18 to 20 ft/lb.



DANGER

Never extend or move the tower in any way while persons are on the tower.

NOTE: The hydraulic oil tank is located behind the outriggers control panel.

Hydraulic Oil Tank

Located behind the outrigger, this tank has a capacity of 65 gallons. It has a special filter screen installed. The oil level can be seen in the sight glass on the side of the tank. The hydraulic oil furnished in the tank is ATF Dex Merc.



CAUTION

When checking or adding oil, make sure all hydraulic systems are at rest (retracted). Failure to do so will result in overfilling the system.

HYDRAULIC OIL SPECIFICATIONS:

ANY OIL CHANGES OR ADDITIONS SHOULD BE DEX MERC,
FILTERED TO AT-LEAST ISO 22/18/13 CLEANLINESS LEVEL.

UN-FILTERED OIL MAY ACCELERATE WEAR AND DECREASE
PERFORMANCE OF SOME COMPONENTS.

Tag Dimensions: 3.0" height x 4.0" long

Hydraulic Oil Tank Fill Procedure

NOTE: Use only clean oil to fill reservoir

1. Locate the Hydraulic Tank Fill Port behind the outrigger.
2. Check the current oil level. Proceed only if it is below the full level. If it is at, or above the full mark, the system is full.

NOTE: you can locate the high psi filter under the cab

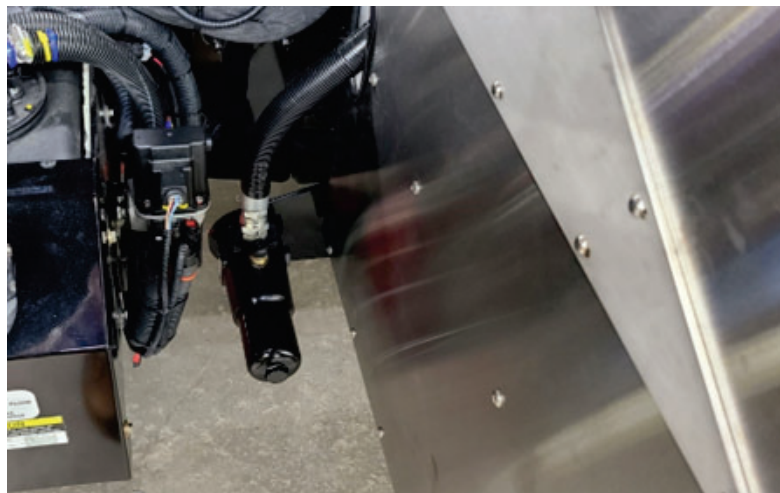
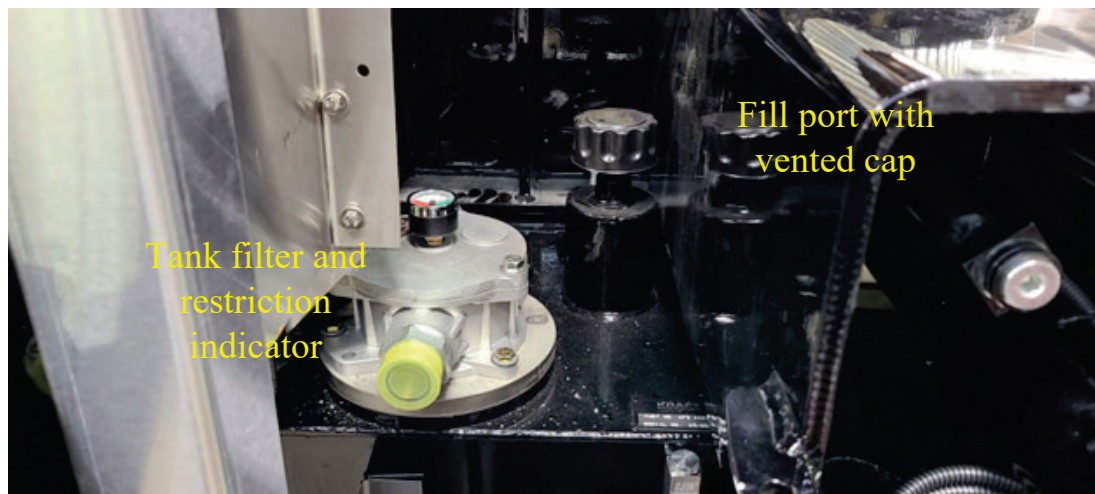



SPH 100 Fitted with KFS 4447 Reservoir Assembly

The reservoir assembly is fitted with a tank top filter and sight glass. The cylinders should all be stowed except for the left-side, jack-extend cylinder which needs to be extended 24 inches to gain access to the sight gauge and return filter (behind control panel). The full mark on the sight gauge is 3-5 inches from the top of the tank.

Hydraulic fluid should be changed every 500 hours of operation or once a year, whichever comes first. The hydraulic oil furnished in the tank is ATF Dex Merc.

The return filter is fitted with a by-pass indicator. Change this filter if the by-pass indicator is going into the red. This must be observed when the unit is in operation. With the unit fully set up at high idle, observe the by-pass indicator. When running at high idle, retract and lower at the same time. This is the highest flow rate the filter will see. Otherwise, change this filter after the first 50 hours of operation and 250 hours thereafter.

Please replace with MP Filtri original equipment element # MF180A10HB.

When checking the high-pressure filter, the hydraulic system must be in operation with multiple functions being performed (for example: extend, lower, or retract ladder). If the indicator on the filter housing is in the green zone, the filter is good. If the indicator on the filter housing is in the red zone, replace the filter. When the truck is put into service, replace the filter after the first 25 hours of operation. After that, replace the filter as needed according to the filter indicator on the housing.

Maintenance Manual

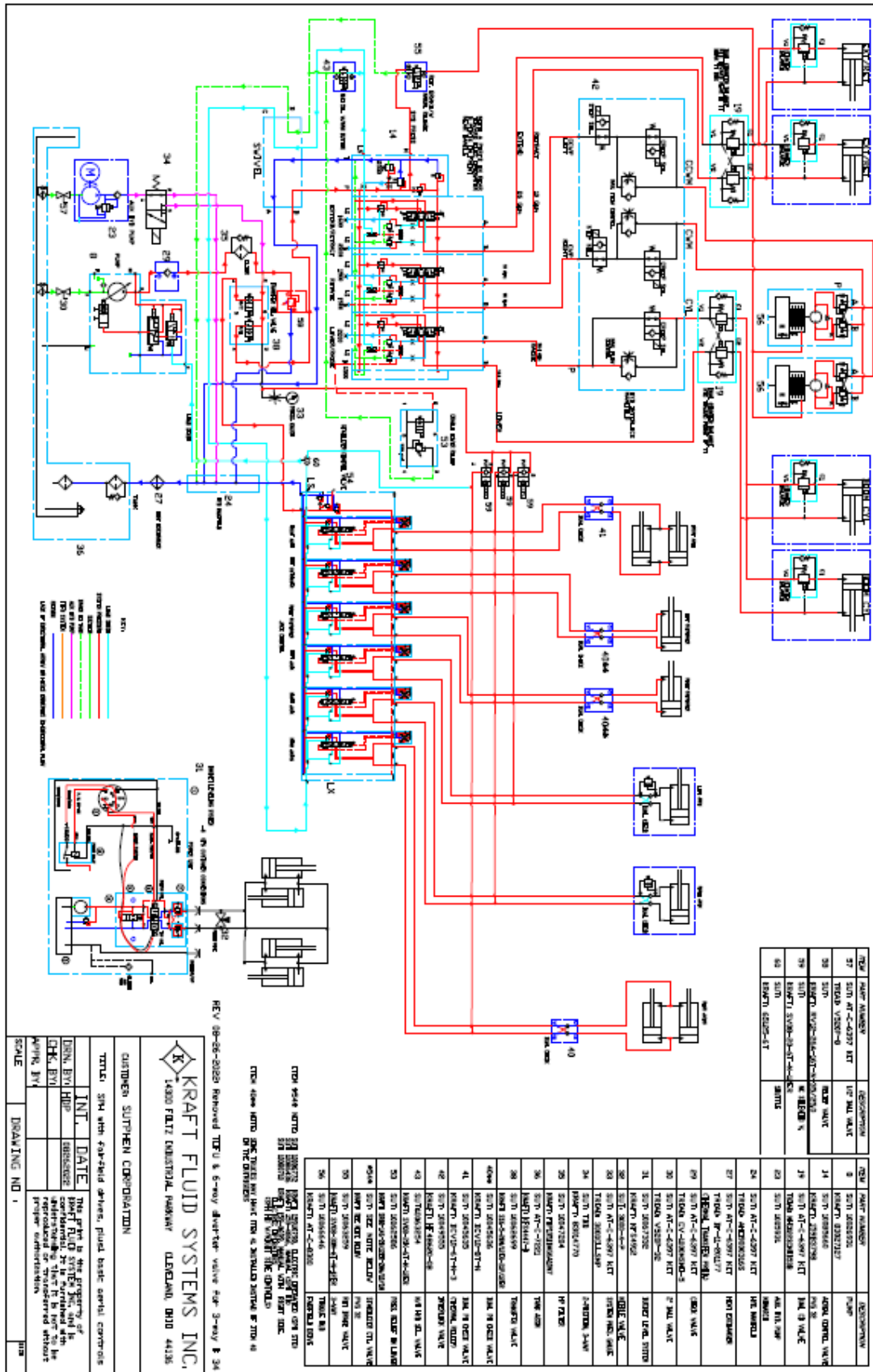



Fuel Tank

The fuel tank is located behind rear axle. It has a capacity of 65 gallons. The filler for the tank is located on the right- or left-rear fender panel, depending on option. A nameplate marked Diesel Fuel Only is attached near the filler for proper identification. Use #2 diesel fuel under normal conditions.

2.2 Maintenance of Structure

Aluminum Tower Structure

The tower structure members are #6061-T6 aluminum alloy extrusion. This alloy is very resistant to corrosion and requires very little maintenance. Periodic washing with clear water only is recommended. Use mineral spirits for removal of tar, oil, and smoke film. If a brighter appearance is desired, use any quality automotive polish, a mag and aluminum wheel cleaner, or a Scotchbrite pad.

Attachment of Support Structure to Truck Frame

There are twelve Huck bolts - retorque not required.

Any indication of loosening or bolt failure should be reported to Sutphen Corporation for evaluation and disposition.

NOTE: Sutphen recommends that once a week the ladder should be raised to full elevation, full extension, then rotated completely 360 degrees in both directions.

Chassis Maintenance

Refer to the Operator and Maintenance Manual for detailed procedures.

NOTE: Specific to aerial towers, the fuel beam corners must be cleaned out and touched up as needed.

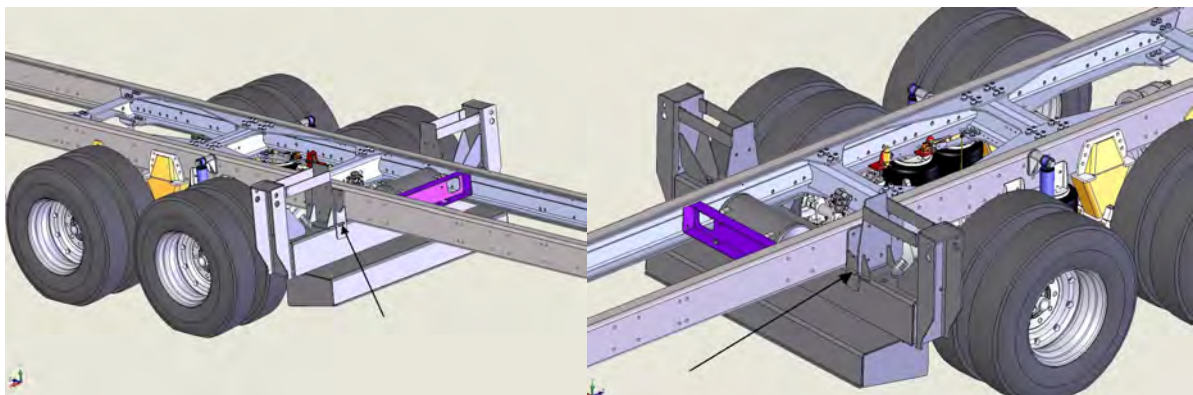



2.3 Aerial Tower Lubrication Requirements

ITEM	LUBRICANT
CABLES	ATF/Dex Merc
SHEAVE PINS/BEARINGS	High - Mid Multipurpose Grease/ ProOne Grease
CYLINDER PINS	High - Mid Multipurpose Grease/ ProOne Grease
LIFT	High - Mid Multipurpose Grease/ ProOne Grease
LEVELING	High - Mid Multipurpose Grease/ ProOne Grease
EXT./RET	High - Mid Multipurpose Grease/ ProOne Grease
PIVOT SHAFT BEARINGS	High - Mid Multipurpose Grease/ ProOne Grease
ROTATION GEAR & PINION	Open Gear Grease
ROTATION BEARING	High - Mid Multipurpose Grease/ ProOne Grease
PINION (LOWER) BEARING	High - Mid Multipurpose Grease/ ProOne Grease
ROTATION GEAR REDUCER (WINSMITH)	High - Mid Multipurpose Grease/ ProOne Grease
BEARINGS (GREASE FITTINGS)	High - Mid Multipurpose Grease/ ProOne Grease
GEAR BOX	
SLIDE BLOCKS	ProOne Grease
SLIDE BLOCKS IN SERVICE / NO DRY LUBE	ProOne Grease
WATERWAY	ATF
FAIRFIELD DRIVE	ATF (Site Window Located In The Brake On Top Of Fairfield Drive)

Maintenance Manual

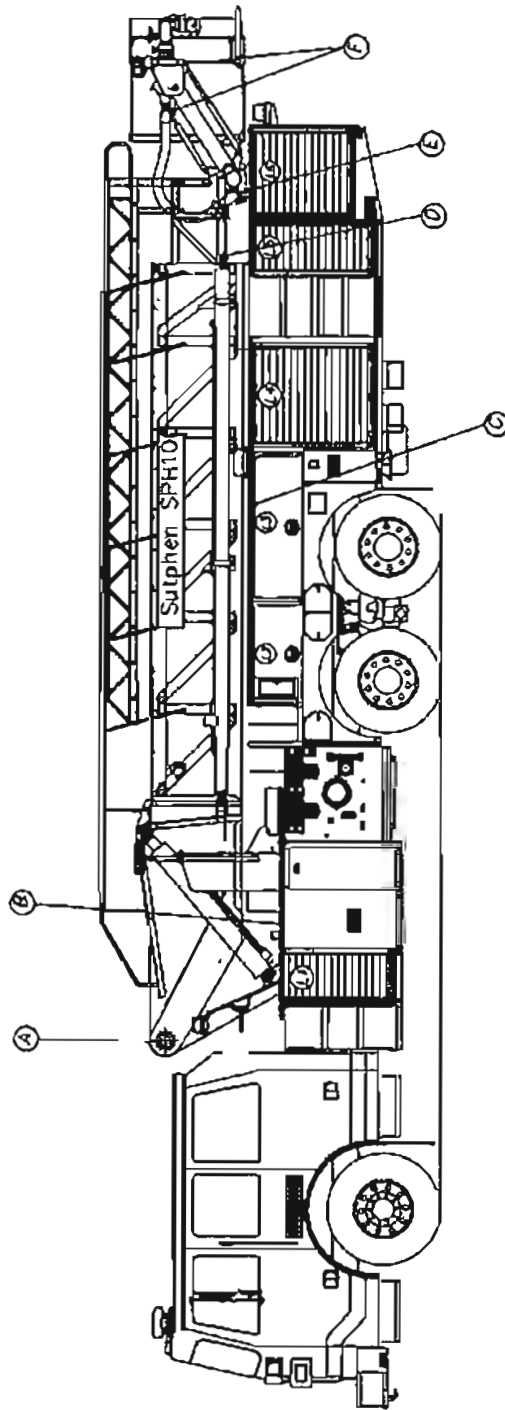



2.4 Torque Values for Various Fasteners

See drawings for location of various fasteners.

LOCATION	# OF BOLTS	GRADE	SIZE	TORQUE FT/LBS
(A) PIVOT SHAFT BEARINGS	24	8	1/2-13 NC	55-60
(B) PIVOT SHAFT END CAPS	16	8	7/16-14 NC	35-40
(C) WATERWAY SUPPORT	2	8	3/4-10 NC	150-200
(D & I) LIFT CYLINDER PIN RETAINERS	4	8	1/2-13 NC	40-50
(E) ROTATION GEAR MOUNTING PLATE (WINSMITH)	7	8	1/2-13 NC	75-85
ROTATION GEAR MOUNTING (WINSMITH)	4	8	5/8-11 NC	175-185
(E) ROTATION GEAR MOUNTING PLATE (PERFECTION)	8	8	1/2-13 NC	75-85
ROTATION GEAR MOUNTING (PERFECTION)	6	8	5/8-11 NC	175-185
(E) ROTATION GEAR MOUNTING PLATE (FAIRFIELD)	24	8	1/2-13 NC	75-85
ROTATION GEAR MOUNTING (FAIRFIELD)	18	8	9/16-12 NC	75-85
(F) ROTATION BEARING TO SUPPORT STRUCTURE	36	8	3/4-10 NC	225-250
(F) TURNTABLE TO ROTATION BEARING	36	8	3/4-10 NC	225-250
(G) CURVED PLATE AT PIVOT SHAFT	6	8	3/8-16 NC	25-30
(H) CABLE TRAY SUPPORT	2	8	3/4-10 NC	150-200
(J) TURNTABLE SUPPORT TO FRAME	24	HUCK BOLTS	16mm	NONE
(J) TURNTABLE SUPPORT TO FRAME	16	8	3/4-10 NC	250-300
(K) STABILIZER JACK CYLINDER ATTACH	8	8	1-8 NC	550-600
(L) EXTEND/RETRACT CYLINDER PIN RETAINERS	2	8	3/8-16 NC	15-20
(M) EXTENSION CYLINDER SUPPORTS	4	8	3/8-16 NC	30-36
CABLE CLAMPS	4	-	3/8-16 NC	12-15
(M) SHEAVE BEAMS	16/14	8	3/8-16 NC	30-36
(N) YOKE TO LADDER	24	8	3/8-16 NC	25-30
(O) EXTEND/RETRACT CYLINDER ROD BOLT	2	8	3/4-10 NC	155-160
	4	8	3/8-16 NC	15-20
(P) PLATFORM TO YOKE PIVOT	2	8	1/2-13 NC	75-85
	2	-	1/2-13 NC	SNUG
(Q) REAR JACK CYLINDER U-BOLTS	As- Built	8	1/4-20 NC	5





2.4 Torque Values for Various Fasteners Cont.

See drawings for location of various fasteners.

LOCATION	# OF BOLTS	GRADE	SIZE	TORQUE FT/LBS
(L) LADDER LACING BOLTS	As-Built	8	5/16-18 NC	5
(R) LADDER LACING BOLTS	As-Built	8	3/8-16 NC	5

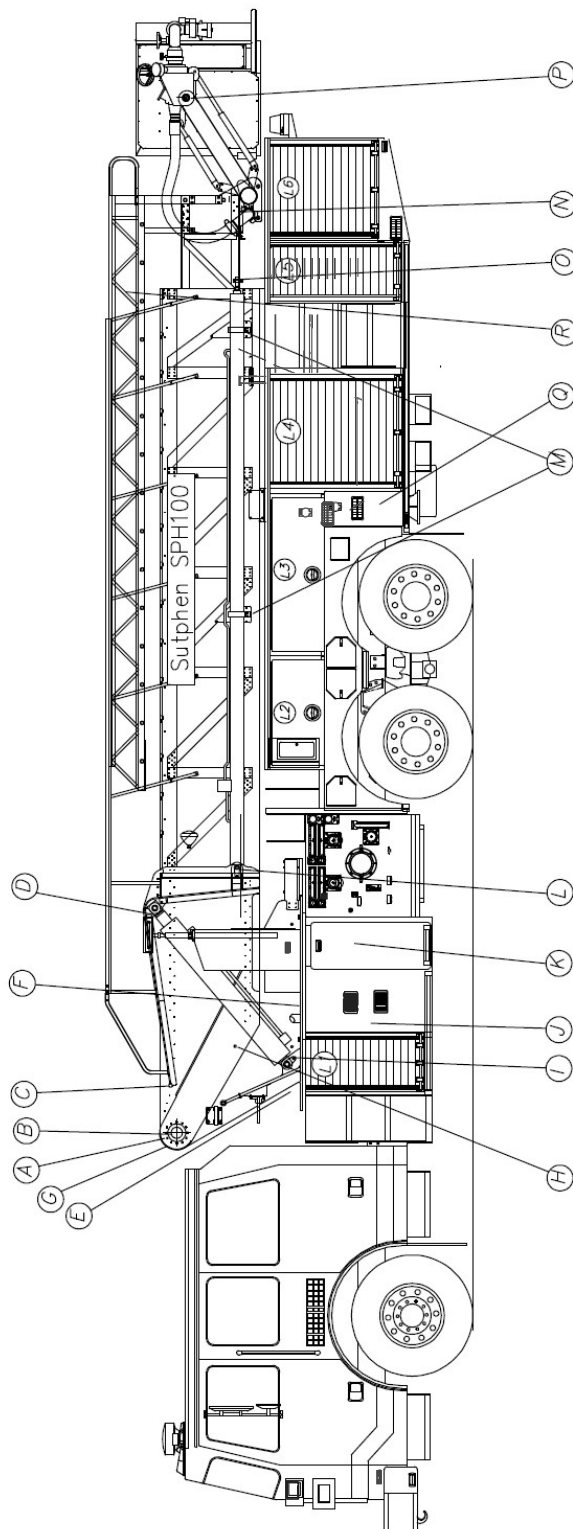

SPH 100 BOLT LOCATIONS

Maintenance Manual

(R) PICTURE FRAME, TOP WELDMENT

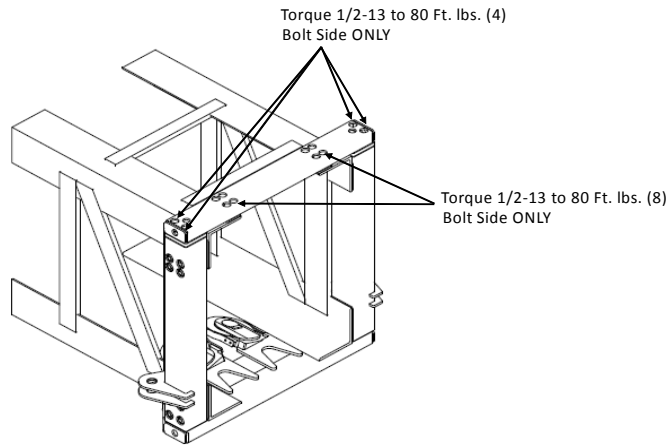

(S) PICTURE FRAME, LOWER ASSEMBLY

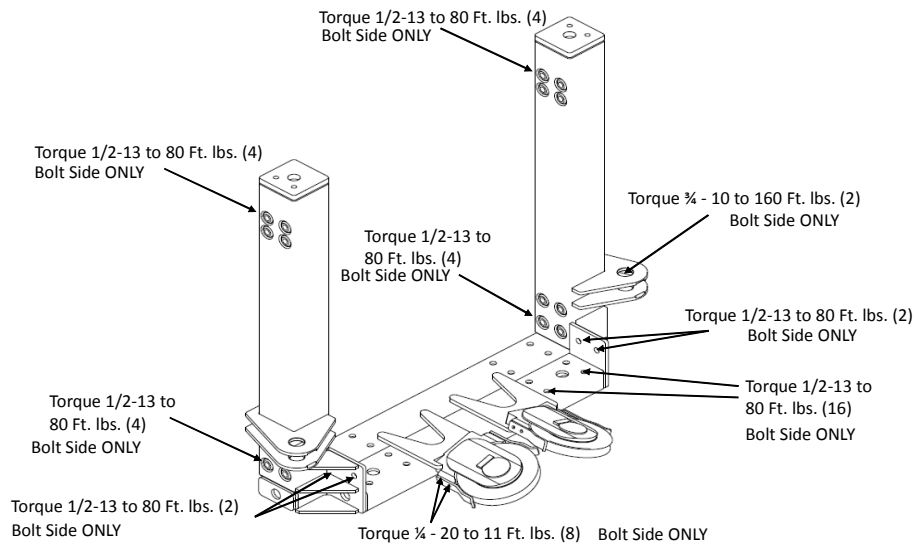



(T) SUPPORT ASSEMBLY, LOWER SECTION 2

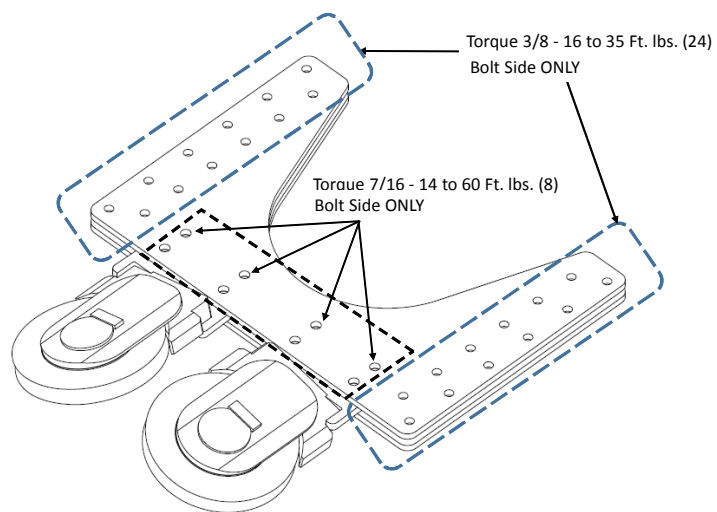

(U) CABLE ANCHOR BEAM, WELDED, ASSEMBLY

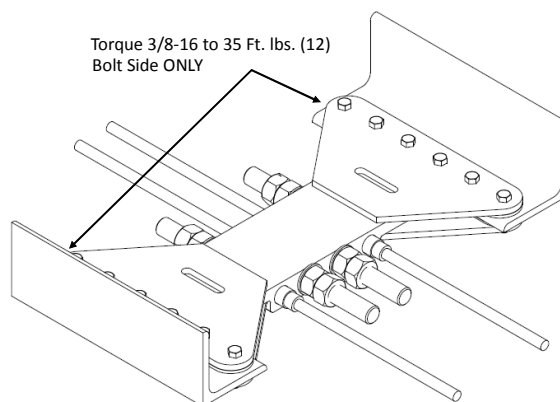

▼ **Maintenance Manual**

(V) CABLE ANCHOR, FIXED END

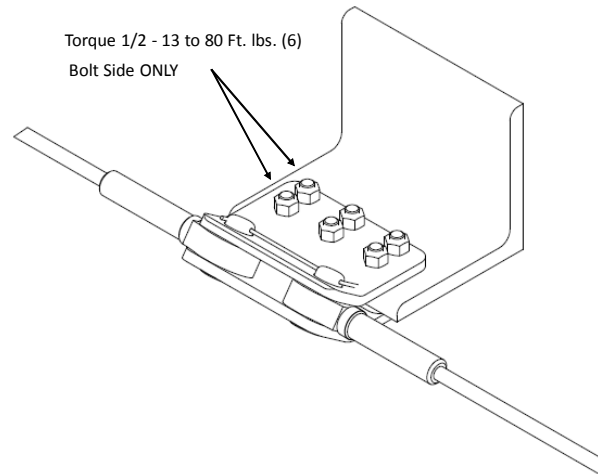

**WALK-AROUND CHECKS
FOR MOBILE FIRE APPARATUS**

Fire Department Name:	Date:	Special Instructions:
Truck Model:	HS #:	
Truck Number:	Station #:	
Start Mileage:	Start Engine Hours:	
End Mileage:	End Engine Hours:	

Legend: Rec Min. = Recommended Minimum Interval for Inspection

OPERATIONS	Daily	Weekly	Monthly	6 Months	Annual
Engine – Tilt Cab – Make sure safety prop is engaged and there are no obstructions on the bumper or in the cab.					
1. Check engine oil and transmission level. Check for leaks (see Manual).	Rec Min.				
2. Check engine coolant level – sight glass. Check for leaks.	Rec Min.				
3. Check for integrity of frame and suspension, as well as motor assembly and mount. Check for loose bolts.			Rec Min.		
4. Check power steering fluid level and look for leaks at fitting or hoses.	Rec Min.				
5. Check belts for tightness and wear.	Rec Min.				
6. Check steering shafts.			Rec Min.		
7. Check for exhaust leaks. Check heat shields are in place.			Rec Min.		
Outside					
1. Check for fluid leaks under vehicle.	Rec Min.				
2. Check steering shafts and linkages.			Rec Min.		
3. Check wheels and lug nuts for tightness.			Rec Min.		
4. Check tire condition. – Tread Depth. (wear/damage)	Rec Min.				
5. Check tire air pressure.	Rec Min.				
6. Verify all warning label & placards are in place (see Manual).		Rec Min.			
7. Check driveline U-joints and slip joints. Lubricate if necessary. Check for tightness on all universal bolts. Visual check.			Rec Min.		
Cab – lower cab					
1. Check seats and seat belts (damage/warning system) and ensure working properly.	Rec Min.				
2. Start engine, check all gauges, switches, & controls.	Rec Min.				
3. Check windshield wipers & washer fluid level check	Rec Min.				
4. Check rear view mirrors adjustment and operation. R & L	Rec Min.				
5. Check horn, air horn, siren and backup alarm.	Rec Min.				
6. Check all gauges for correct reading after start. Fuel Level Check.	Rec Min.				
7. Check cab glass and mirrors.	Rec Min.				
Body					
1. Check steps and running boards. (damage/loose hardware)	Rec Min.				
2. Check body condition. (doors/latching)	Rec Min.				
3. Check grab handles. (hardware tight secure)	Rec Min.				
Electric					
1. Check battery voltage and charging system voltage, 13 +VDC.	Rec Min.				
2. Check all lights (ICC and warning); headlights.	Rec Min.				

OPERATIONS	Daily	Weekly	Monthly	6 Months	Annual
3. Check operation of battery charger and receptacle.	Rec Min.				
Brakes					
1. Check air system for proper air pressure. (see tech manual)	Rec Min.				
2. Check parking brake operation.	Rec Min.				
3. Check air compressor operations. Cut in _____ Cut out _____	Rec Min.				
4. Check hoses or lines for rubbing.			Rec Min.		
5. Drain wet air tank to make sure air dryer is working properly			Rec Min.		
Pump					
1. Operate pump, check pump panel engine gauges.	Rec Min.				
2. Check pump for pressure operation.	Rec Min.				
3. Check discharge relief or pressure governor operation.	Rec Min.				
4. Check all pump drain valves.		Rec Min.			
5. Check all discharge and intake valve operation.		Rec Min.			
6. Check pump and tank for water leaks.		Rec Min.			
7. Check all valve bleeder/drain operation.		Rec Min.			
8. Check primer pump operation.			Rec Min.		
9. Check system vacuum hold.			Rec Min.		
10. Check water tank level indicator.	Rec Min.				
11. Check primer oil level (if applicable).		Rec Min.			
12. Check transfer valve operation (if equipped).			Rec Min.		
13. Check booster reel operation (if equipped).		Rec Min.			
14. Check all pump pressure gauge operation.	Rec Min.				
15. Check all cooler valves.			Rec Min.		
16. Check for oil leaks in pump area.	Rec Min.				
17. Check oil level of pump transmission.			Rec Min.		
18. Check hour meter operation (If equipped)	Rec Min.				
19. Check operation of valve linkage.	Rec Min.				
20. Check ball valves for leaks.		Rec Min.			
21. Check drain valves.		Rec Min.			
Generator					
1. Operations – Hydraulic, Gas, or Diesel	Rec Min.				
2. Fluid levels	Rec Min.				
3. Breakers, Receptacles, lighting for operations		Rec Min.			
4. Voltage Reading, 240V AC		Rec Min.			
Amp Reading		Rec Min.			
HTZ Reading, 60HTZ		Rec Min.			
Aerial Device					
1. Visually inspect aerial structure, slide blocks, cables, sheaves, lacing bolts/ huck bolts and any moving assembly.		Rec Min.			
a. Sheaves – lubed and look for signs of wear		Rec Min.			
b. Slide blocks – all in place (no visible signs of excess wear or damage)		Rec Min.			
2. Check aerial operation – all controls, bucket & pedestal.		Rec Min.			
3. Elevation cylinder, check for leaks & wiper seal (check RAM for pits and/or damage).		Rec Min.			
4. Extension cylinder, check for leaks & wiper seal (check RAM for pits and/or damage).		Rec Min.			
5. Lines & hoses – check for leaks and cuts.		Rec Min.			
6. Check aerial hour meter operation and record hours.		Rec Min.			

OPERATIONS	Daily	Weekly	Monthly	6 Months	Annual
7. Check breathing air system.		Rec Min.			
8. Cable adjustment not too tight and not too loose check all cables and sections. Review tolerance. (See directions in manual)			Rec Min.		
9. Observe operation of cable track system check for debris and/or damage.		Rec Min.			
Waterway					
1. Check waterway system operation, alignment, and check for damage.		Rec Min.			
Hydraulic System					
1. Check aerial hydraulic fluid level. Dex/Merc		Rec Min.			
2. Check high pressure filter under load to ensure it is still in the green and not in bypass as well as return the filter.		Rec Min.			
3. Turn on auxiliary hydraulic power pump – check operation.		Rec Min.			
Turntable					
1. Operate aerial hydraulics + PTO operation (check for leaks or damaged hoses). Verify Indicator Light is functional.		Rec Min.			
2. Rotation		Rec Min.			
3. Rotation hydraulic swivel, check for leaks		Rec Min.			
4. Lines and hoses (for leaks & cuts)		Rec Min.			
5. Pivot pin bolts tight on boom to turn table pivot bearing plate (Heal Pin).			Rec Min.		
6. Check manual overrides.			Rec Min.		
7. Check cradle alignment light and mounting.		Rec Min.			
8. Check pinion and rotation bearing (Winsmith/rotation drives).			Rec Min.		
Turntable Components or Hydraulic Compartment					
1. Safety signs			Rec Min.		
2. Communication system or intercom		Rec Min.			
3. Interlock systems - operational		Rec Min.			
4. High-speed button operational		Rec Min.			
Platform/Bucket					
1. Leveling cylinders, leaks and wiper seal		Rec Min.			
2. Lines and hoses, cuts & leaks		Rec Min.			
3. Check operation of high speed.		Rec Min.			
4. Check operation of intercom system		Rec Min.			
Platform/Bucket (continued)					
5. Check breathing air system in platform - check for leaks and hose condition		Rec Min.			
6. Inspect monitors/turret for operation		Rec Min.			
7. Verify cab avoidance system is operational		Rec Min.			
8. Verify bucket leveling system is operational		Rec Min.			
9. Verify all accessories are secure in the platform		Rec Min.			
Structural Fasteners - See Manual for Reference					
1. Turntable mounting bolts - visual check for tightness				Rec Min.	
2. Chassis Suspension system bolts – visual check for tightness				Rec Min.	
Stabilizers					
1. Check aerial outrigger operation		Rec Min.			
2. Check aerial jack & rotation interlocks for operation		Rec Min.			
3. Indicator lights working		Rec Min.			
4. Jack pads in proper location & serviceable		Rec Min.			
5. Mounting bolts – visual check for tightness		Rec Min.			
6. Verify safety lock pins operation in aerial jacks and in location		Rec Min.			

OPERATIONS	Daily	Weekly	Monthly	6 Months	Annual
7. Cylinders – check for leaks & wiper seals		Rec Min.			
8. Control valve – smooth operation		Rec Min.			
9. Lines & hoses – check for leaks and cuts		Rec Min.			
10. Diverter valve – check for leaks		Rec Min.			
Lubrication					
Grease Parts and Assemble as Required per the Trucks Maintenance Manual:					
1. Sheaves - Min. Wkly or more if hours of operation dictate		Rec Min.			
2. Cables, wipe down with oil, Dex/Merc		Rec Min.			
3. ProOne Grease on boom section, Review and add where needed per manual		Rec Min.			
4. Rotation gear and bearing				Rec Min.	
5. Rotation gear reduction box				Rec Min.	
6. Extension cylinder pins, grease pivot				Rec Min.	
7. Stabilizer extension cylinder pins				Rec Min.	
8. Aerial waterway pipe sections, wipe with Dex/Merc		Rec Min.			
9. Grease turret guns		Rec Min.			
10. Lightly apply Dex/Merc to Cable trough sections - Do Not Over Apply		Rec Min.			
Indicators					
1. Validate rung alignment operation; pedestal and bucket		Rec Min.			
2. PTO engaged in cab		Rec Min.			
3. Aerial alignment light for cradle bedding		Rec Min.			
4. Elevation/inclometer in bucket		Rec Min.			
5. Inclometer in turntable area for truck level.		Rec Min.			
Comments:					



Chapter 3 Warranty

	<u>Page</u>
Aerial Platform or Aerial Ladder Structural and Corrosion Warranty	
Thirty (30) Years.....	3-3
Aerial Platform and Aerial Ladder Mechanical Warranty	
Two (2) Years	3-4



AERIAL PLATFORM OR AERIAL LADDER STRUCTURAL & CORROSION WARRANTY THIRTY (30) YEARS

SUTPHEN CORPORATION (Sutphen) warrants the original user/purchaser that a new aerial platform or aerial ladder is, and will remain, free of corrosion perforation and structural defects, provided the aerial platform is used in a normal and reasonable manner. An aerial platform or aerial ladder is defined as the mechanically operated telescopic boom constructed of high-strength structural aluminum mounted on the fire truck. Excluded are all hardware, mechanical or electrical items, bucket, yoke and all normal wear items. Truck must be third party tested yearly. The Sutphen hourly maintenance schedule must be sent in to Sutphen for documentation that this work was performed per hourly schedule. This Structural Warranty shall supplement the Standard Vehicle Warranty.

Sutphen's obligation under this limited warranty is subject to the conditions precedent (1) that the claimed failure shall have first appeared during the warranty period; (2) that the original purchaser shall have notified Sutphen in writing of the claimed failure within thirty (30) days after the claimed failure shall have first appeared, and (3) that, unless Sutphen directs otherwise, the claimed failed item or items shall have been returned to Sutphen, or to Sutphen designee, promptly after the notification, with transportation charges prepaid. Sutphen reserves the right to thoroughly examine the vehicle or parts thereof, prior to conducting or approving any repair or replacement, to determine whether the claimed failure is covered by this warranty. Sutphen's obligation under this warranty is strictly limited to repair or replacement as the company may elect.

This limited warranty coverage shall be valid for a period of thirty (30) years from the delivery date to the original user/purchaser. Further, this warranty shall be void if the vehicle is involved in an accident, shows signs of abuse, or evidence of being operated in any improper manner.

This limited warranty covers only repair or replacement of any part of a Sutphen vehicle in which a defect in materials or workmanship appears within the limited warranty period. Examples of items not covered include, but are not limited to:

- A. ---Major components or trade accessories such as purchased chassis, engines, signaling devices, batteries, generators, tires, or transmissions that have a separate warranty by the original manufacturer, or to equipment used in fire fighting.
- B. ---Unauthorized alteration or modification to the vehicle, including the body, chassis or components, after completion of the vehicle assembly by Sutphen and any problems that occur as a result of such alterations or modifications.
- C. ---Damage caused by collision, fire, theft, freezing, vandalism, riot, explosion, acts of God, war or objects striking the vehicle or any damage covered by owner insurance.
- D. ---Damage caused by misuse or improper operation of the vehicle such as driving over curbs, overloading, racing or off-road use.
- E. ---Damage caused by failure to follow the requirements of the maintenance schedule, failure to maintain proper fluid and lubricant levels and failure to follow operating instructions.
- F. ---Towing charges and storage expenses.
- G. ---Incidental expenses such as loss of vehicle use, inconvenience, loss of time, vehicle rental, lodging or travel costs, vacation pay, etc.
- H. ---Hydraulic pressures are not set to the correct PSI
- I. ---Damage caused from exposure to road de-icing compounds or use in an acidic environment.
- J. ---Hydraulic failures caused by incorrect or contaminated oil.
- K. ---Hydraulic cylinder seal after one (1) year of service.

If proper maintenance has not been performed and documented on Sutphen Aerial Platform or Aerial Ladder Inspection forms and the forms sent to Sutphen at the time of check, all coverage is void.

This warranty terminates upon transfer of possession or ownership of the vehicle from the original purchaser.

THIS WARRANTY IS PROVIDED IN EXCLUSION OF ANY AND ALL OTHER REPRESENTATIONS, EITHER EXPRESSED OR IMPLIED, INCLUDING BUT NOT LIMITED TO THE WARRANTIES OF MERCHANTABILITY, FITNESS, AND SUITABILITY FOR BUYER'S INTENDED USE. NO PERSON IS AUTHORIZED TO MAKE ANY REPRESENTATIONS OR WARRANTIES ON BEHALF OF SUTPHEN CORPORATION OTHER THAN SET FORTH HEREIN. ANY MODIFICATION TO THIS WARRANTY MUST BE IN WRITING AND APPROVED BY THE PRESIDENT OF SUTPHEN CORPORATION. THE PROVISIONS OF THIS LIMITED WARRANTY SHALL CONSTITUTE THE SOLE AND EXCLUSIVE REMEDIES OF A SUTPHEN VEHICLE PURCHASER.

For more information contact:
Sutphen Corporation / Warranty Admin.
PO Box 1845 • Springfield, OH 45501
Phone (937) 969-8851 • Toll Free (866) 287-5549



AERIAL PLATFORM AND AERIAL LADDER MECHANICAL WARRANTY TWO (2) YEARS

SUTPHEN CORPORATION (Sutphen) warrants the original user/purchaser that the mechanical components of a new aerial platform or aerial ladder is, and will remain, free of corrosion perforation, structural defects or failure provided that the components are used in a normal and reasonable manner. Mechanical components are defined as the hardware and mechanical items used on an aerial device. This Mechanical Warranty shall supplement the Standard Vehicle Warranty.

Sutphen's obligation under this limited warranty is subject to the conditions precedent (1) that the claimed failure shall have first appeared during the warranty period; (2) that the original purchaser shall have notified Sutphen in writing of the claimed failure within thirty (30) days after the claimed failure shall have first appeared, and (3) that, unless Sutphen directs otherwise, the claimed failed item or items shall have been returned to Sutphen, or to Sutphen designee, promptly after the notification, with transportation charges prepaid. Sutphen reserves the right to thoroughly examine the vehicle or parts thereof, prior to conducting or approving any repair or replacement, to determine whether the claimed failure is covered by this warranty. Sutphen's obligation under this warranty is strictly limited to repair or replacement as the company may elect.

This limited warranty coverage shall be valid for a period of two (2) years from the delivery date to the original user/purchaser. Further, this warranty shall be void if the vehicle is involved in an accident, shows signs of abuse, or evidence of being operated in an improper manner.

This limited warranty covers only repair or replacement of any part of a Sutphen vehicle in which a defect in materials or workmanship appears within the limited warranty period. Examples of items not covered include, but are not limited to:

- A. ---Major components or trade accessories that have a separate warranty by the original manufacturer, or equipment used in fire fighting.
- B. ---Unauthorized alteration or modification to the vehicle, including the aerial, body, chassis or components, after completion of the vehicle assembly by Sutphen and any problems that occur as a result of such alterations or modifications.
- C. ---Damage caused by collision, fire, theft, freezing, vandalism, riot, explosion, acts of God, war or objects striking the vehicle or any damage covered by owner insurance.
- D. ---Damage caused by misuse or improper operation of the vehicle such as driving over curbs, overloading, racing or off-road use.
- E. ---Damage caused by failure to follow the requirements of the maintenance schedule, failure to maintain proper fluid and lubricant levels and failure to follow operating instructions.
- F. ---Normal maintenance items such as lubrication, cables, shives, pivot bearings, pivot shafts, etc.
- G. ---Towing charges and storage expenses.
- H. ---Incidental expenses such as loss of vehicle use, inconvenience, loss of time, vehicle rental, lodging or travel costs, vacation pay, etc.
- I. ---Damage to discharge and compound gauges from freezing.
- J. ---Leaking seals on discharge and suction valves.
- K. ---Damage caused from exposure to road de-icing compounds or use in an acidic environment.
- L. ---Hydraulic failures caused by incorrect or contaminated oil.
- M. ---Hydraulic pressure caused by incorrect PSI settings.
- N. ---Hydraulic cylinder seal after one (1) year service.
- O. ---Electric reels, air reels, electric controls and components.

If proper maintenance has not been performed and documented on Sutphen Aerial Inspection forms and sent to Sutphen at time of check, all coverage is void.

This warranty terminates upon transfer of possession or ownership of the vehicle from the original purchaser.

THIS WARRANTY IS PROVIDED IN EXCLUSION OF ANY AND ALL OTHER REPRESENTATIONS, EITHER EXPRESSED OR IMPLIED, INCLUDING BUT NOT LIMITED TO THE WARRANTIES OF MERCHANTABILITY, FITNESS, AND SUITABILITY FOR BUYER'S INTENDED USE. NO PERSON IS AUTHORIZED TO MAKE ANY REPRESENTATIONS OR WARRANTIES ON BEHALF OF SUTPHEN CORPORATION OTHER THAN SET FORTH HEREIN. ANY MODIFICATION TO THIS WARRANTY MUST BE IN WRITING AND APPROVED BY THE PRESIDENT OF SUTPHEN CORPORATION. THE PROVISIONS OF THIS LIMITED WARRANTY SHALL CONSTITUTE THE SOLE AND EXCLUSIVE REMEDIES OF A SUTPHEN VEHICLE PURCHASER.

For more information contact:
Sutphen Corporation / Warranty Admin.
PO Box 1845 • Springfield, OH 45501
Phone (937) 969-8851 • Toll Free (866) 287-5549